



MINI ROLL CND

Safety contact edges for swing gates

🇮🇹 Il modello MINI ROLL CND è stato progettato per l'utilizzo sui cancelli a battente, installato sul perimetro del cancello sia in posizione verticale che in posizione orizzontale. Utilizza un profilo conduttivo in TPE coestruso al suo interno che garantisce risposte rapide ad ogni impatto ed è accorciabile infinitamente. MINI ROLL CND è disponibile in comodi kit, pensati per poter comporre diversi spezzoni di lunghezza a piacimento.

🇬🇧 Model MINI ROLL CND is designed to be used on swing gates and installed on the perimeter of the gate both in vertical position and in horizontal position. It features an inner TPE conductive profile which guarantees quick response to every impact, the bar can be cut down at will at any length. MINI ROLL CND is available in a handy kit which includes all the necessary items to produce several segments of different lengths.

🇫🇷 Le modèle MINI ROLL CND a été pensé pour être installée sur le périmètre du portail aussi bien en position verticale qu'horizontale. Il utilise un caoutchouc conducteur en TPE co-extrudé qui garantit un temps de réponse rapide à l'impact et est recoupable indéfiniment. MINI ROLL CND Il est disponible en kit pratiques et conçus pour réaliser plusieurs palpeurs de longueurs variées.

🇩🇪 Das Modell MINI ROLL CND wurde für Drehtore ausgelegt und wird umlaufend montiert. Ein intern verlaufendes koextrudiertes Leiterprofil aus TPE ist beliebig ablängbar und gewährleistet das sofortige Ansprechen bei jeder Berührung. MINI ROLL CND Erhältlich als zweckmäßiges Set für das Zusammensetzen in beliebig lange Teile.

🇪🇸 El model MINI ROLL CND fue ideado para ser utilizado en cancelas con bisagra, y puede ser instalado sobre el perimetro de la cancela tanto en vertical y en horizontal. Usa un perfil



**TOTAL
SAFETY**

Safety guaranteed on all border's length, including endcaps.

conduttivo con TPE coestruida al interior para garantir una reacción rapida a cada choque y puede ser acortado infinitamente. MINI ROLL CND Es sidponible en kit ideado para construir piezas de diferente longitud.

APPLICATIONS

SIZES

LENGTHS AND TRIMMING

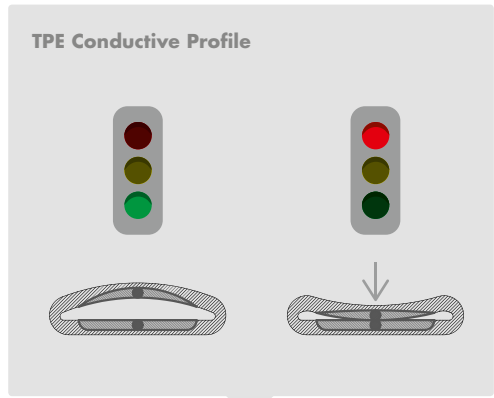
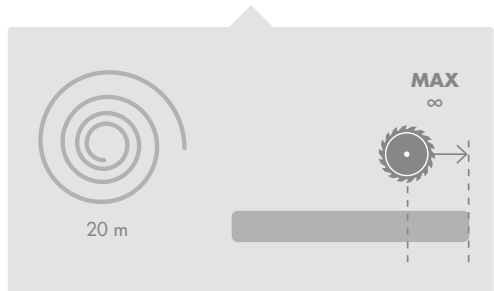
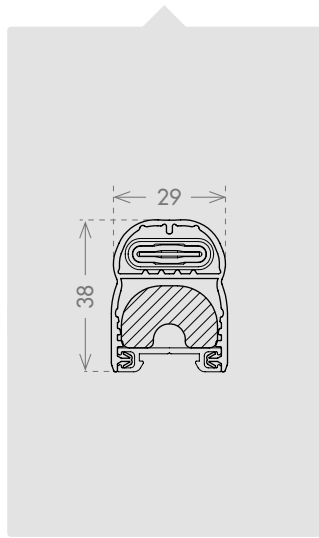
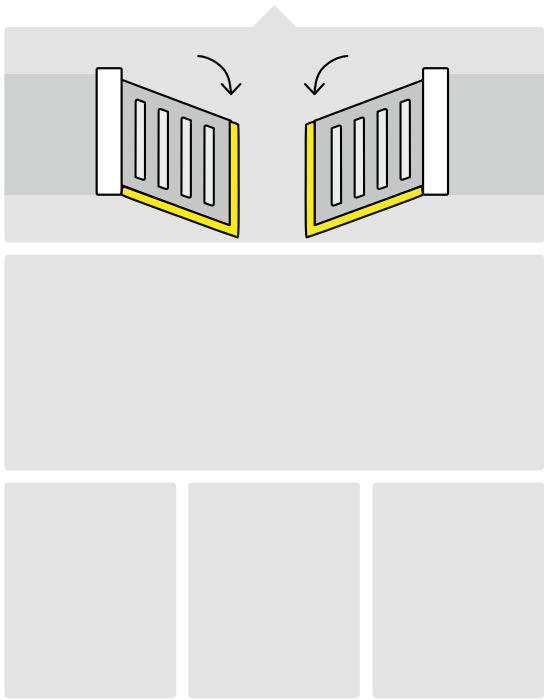

TEMPERATURE

DEVICE IP RATING

TECHNOLOGY

MINI ROLL CND

code: **MINIROLLBOX + MINIROLLALU + MINIROLLCONN**

N.C.

8,2 kΩ

ESTIMATE FOR 10 KIT OF 2MT

MINIROLLBOX

MINIROLLALU

MINIROLLCONN

OPT 1
pg 40

OPT 2
pg 39

ACCESSORY:

code: **PINZACND**

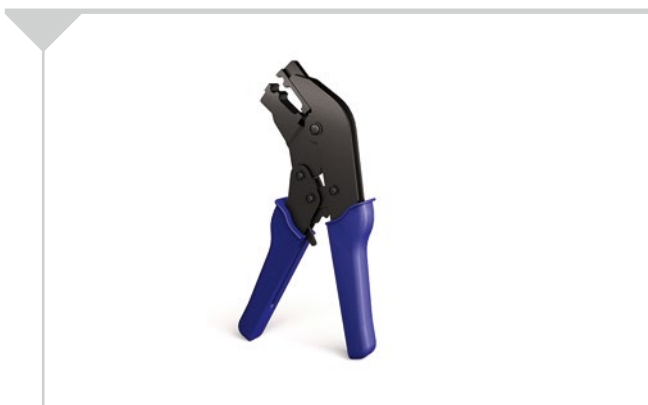

LEGENDA

APPLICAZIONI / APPLICATIONS APPLICATIONS/ ANWENDUNGEN / APLICACIONES

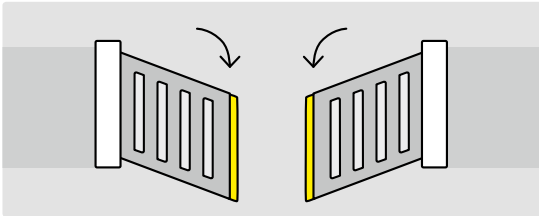

Cancelli a battente.
Swing gates.
Portails battants.
Schwenktore.
Puertas de hoja batiente.

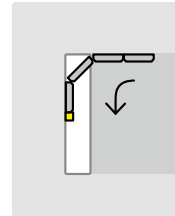

Portoni sezionali.
Sectional doors.
Portes sectionnelles.
Sektionaltore.
Portones seccionales.

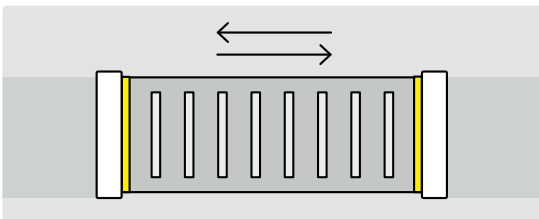

Cancelli scorrevoli.
Sliding gates.
Portails coulissants.
Schiebetore.
Puertas correderas.

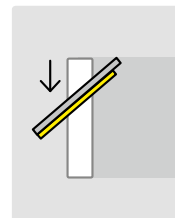

Portoni basculanti.
Overhead doors.
Portes basculantes.
Kipptore.
Portones basculantes.

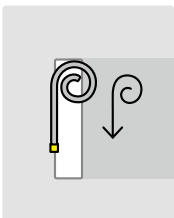

Serrande.
Rolling shutters.
Rideaux.
Rolltore.
Puertas enrollables.

CARATTERISTICHE GENERALI / GENERAL SPECIFICATIONS CARACTERISTIQUES GENERALES / ALLGEMEINE DATEN / CARACTERÍSTICAS GENERALES

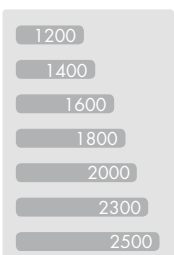

Lunghezze disponibili.
Available lengths.
Longueurs disponibles.
Verfügbare Längen.
Largos disponibles.

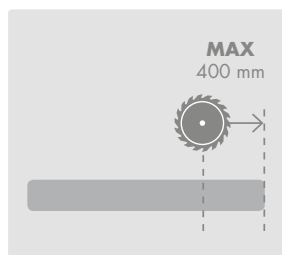

Accorciabilità massima.
Maximum trimming lengths.
Raccourcissement maximum.
Maximale Ablängbarkeit.
Recorte máximo posible.



Temperatura di esercizio.
Working temperature.
Température de fonctionnement.
Betriebstemperatur.
Temperatura de funcionamiento.



Grado di protezione microinterruttori.
Microswitch degree of protection.
Indice de protection des micro interrupteurs.
Schutzart Mikroschalter.
Grado de protección de los microinterruptores.

CARATTERISTICHE MODELLO / MODEL SPECIFICATIONS CARACTERISTIQUES PRODUITS / MODELLSPEZIFISCHE DATEN CARACTERÍSTICAS DEL MODELO



Contatto normalmente aperto (N.A.)
Normally open contact (N.O.)
Contact normalement ouvert (N.O.)
SchlieÙerkontakt (N.O.)
Contacto normalmente abierto (N. A.)



Contatto normalmente chiuso (N.C.)
Normally closed contact (N.C.)
Contact normalement fermé (N.F.)
Öffnerkontakt (N.C.)
Contacto normalmente cerrado (N. C.)



Dispositivo di sicurezza resistivo.
Resistive safety edge.
Dispositif de sécurité résistif.
Widerstands-Schutzvorrichtung.
Dispositivo de seguridad resistivo.



Certificato IMQ.
Certificated by IMQ.
Certificat IMQ.
Zertifiziert durch IMQ als Prüfinstitut.
Certificación IMQ.



Portata massima in campo aperto.
Open field maximum range.
Portée maximum en champ libre.
Maximale Reichweite ungestört.
Alcance máximo en campo abierto.



Canali di trasmissione.
Nr. of transmission channels.
Canaux de transmission.
Übertragungskanäle.
Canales de transmisión.



Comanda fino a ... TX.
Controls up to ... Tx.
Contrôle jusqu'à ... TX.
Betätigung von bis zu ... Sendern.
Controla hasta ... TX.



Alimentazione con batterie al litio 1,5 V.
1,5V lithium batteries transmitter power supply.
Alimentation par piles au lithium 1,5 V.
Stromversorgung durch Lithiumakkus 1,5 V.
Alimentación con pilas de litio de 1,5 V.



Alimentazione 12/24 v AC/DC.
12/24 v AC/DC Power supply.
Alimentation 12/24 v AC/DC.
Betriebsspannung 12/24V AC/DC.
Alimentación: 12/24 VCA/VCC.



Frequenza di trasmissione.
Transmission frequency.
Fréquence de transmission.
Übertragungsfrequenz.
Frecuencia de transmisión.



Collegamento in serie di più coste conduttive.
Series wiring of several conductive safety edges.
Installation de plusieurs palpeurs conducteur en série.
Reihenschaltung mehrerer Kontakteleiste
Conexión en serie de mas dispositivos CND.

OPZIONI / OPTIONALS OPTIONS / OPTIONEN / OPCIONES



Scheda di controllo.
Control boards.
Carte de contrôle.
Steuerkarte.
Tarjeta de control.



Coppia trasmettitore + ricevitore wireless.
Wireless receiver&transmitter.
Couple transmetteur et récepteur sans fil.
Funk-Sender-/Empfängeranlage.
Conjunto de transmisor + receptor inalámbrico.



Ricevitore wireless.
Wireless receiver.
Récepteur sans fil.
Funkempfänger.
Receptor inalámbrico.

