

SAFETY
DIVISION

2025
EDITION



CATALOGO GENERALE
PRODUCT CATALOGUE



SAFETY DIVISION

CONDUCTIVE EDGES

12

MAXXI CND

Safety contact edges for heavy sliding gates

MAXXI CND
MAXXI CND LINK CABLE
MAXXI CND LINK TERMINAL
MAXXI CND RADIO EVO

14

COMPATTA CND

Safety contact edges with compact size

COMPATTA CND
COMPATTA CND LINK CABLE
COMPATTA CND LINK TERMINAL
COMPATTA CND RADIO EVO

16

MINI CND

Safety contact edges with compact size

MINI CND

18

MINI ROLL CND

Safety contact edges for swing gates

MINI ROLL CND

20

MINI LIP CND

Safety contact edges for sectional doors

MINI LIP CND KIT
MINI LIP CND

22

PICCOLA CND

Safety contact edges for gates and industrial use

PICCOLA CND KIT
PICCOLA CND

MECHANICAL EDGES

24

COMPATTA

Small size, great performances

COMPATTA PROTO

26

SICURSTOP

A great classic in safety edges

SICURSTOP CONTROL
SICURSTOP PROTO
SICURSTOP CONTROL RADIO EVO
SICURSTOP PROTO RADIO EVO

28

STOP

From overhead doors to industrial applications, a versatile solution

STOP CONTROL
STOP TARTARUGA CONTROL
STOP PROTO
STOP TARTARUGA PROTO

30

TECNOSTOP

Light but strong

TECNOSTOP CONTROL
TECNOSTOP PROTO

PASSIVE EDGES

32

PASSIVA

Bumpers, for increased safety

COMPATTA PASSIVA
MINI ROLL PASSIVA

ACCESSORIES

36

RADIO EVO

Wireless transmission systems for safety edges

RADIO EVO 868 MHZ
RADIO EVO GHOST 868 MHZ

38

RADIO EVO GHOST

Wireless transmission systems for safety edges. Detects obstacles before impact

RADIO EVO 868 MHZ
RADIO EVO GHOST 868 MHZ

40

SCHEMA DI CONTROLLO

41

ERCOLE CREMAGLIERA

42

STAFFA PIÙ

43

STAFFA EASY

44

PROFILO 30°

The 30° profile for a 360° safety

SAFETY EDGES AT A GLANCE

	MICROSWITCHES TECHNOLOGY				CONDUCTIVE TECHNOLOGY				
	STOP	TECNOSTOP	COMPATTA	SICURSTOP	PICCOLA	MINILIP	MINI	COMPATTA	MAXXI
N.C. Contact	✓ p. 29	✓ p. 31	✓ p. 25	✓ p. 27	✗	✗	✗	✗	✗
8,2KΩ	✓ p. 29	✓ p. 31	✗	✓ p. 27	✓ p. 23	✓ p. 21	✓ p. 17/19	✓ p. 15	✓ p. 13
N.C. Contact + Radio TX Evo	✗	✗	✗	✓ p. 27	✗	✗	✗	✗	✗
8,2KΩ + Radio TX Evo	✗	✗	✗	✓ p. 27	✗	✗	✗	✓ p. 15	✓ p. 13
8,2KΩ + Radio TX Evo Ghost	✗	✗	✗	✗	✗	✗	✗	✓ p. 15	✓ p. 13

COMPANY PROFILE

IT La C.C.E. Costruzioni Chiusure Ermetiche Srl viene fondata nel 1980, iniziando la sua attività con la costruzione di guarnizioni automatiche sottoporta, un accessorio indispensabile ad eliminare la fastidiosa fessura che si crea tra porta e pavimento. L'utilità dell'applicazione e la sorprendente tecnologia applicata a questo accessorio hanno da subito determinato il successo del prodotto. Al settore delle guarnizioni automatiche nel 1994 si affianca un nuovo prodotto, che nasce dallo sviluppo della guarnizione automatica sottoporta a cerniera modello MEC. Il prodotto si chiama STOP, nato per trasferire l'esperienza nel settore delle porte ai portoni basculanti. Utilizza dei microinterruttori di sicurezza stagni, montati su due profili di alluminio con movimento a cerniera. Nel 1996 viene fondato il settore dei Dispositivi di Sicurezza, focalizzato sulla produzione di bordi sensibili per la protezione contro gli urti sulle aperture automatiche. L'attenzione al rispetto delle più recenti normative e l'utilizzo di materiali di prima qualità affermano rapidamente i bordi sensibili C.C.E. tra i migliori sul mercato. Negli anni al rinnovato modello STOP, che viene brevettato, vengono affiancati nuovi modelli per cancelli scorrevoli e

portoni sezionali.

Con il tempo vengono introdotte nuove tecnologie sulla gamma dei prodotti, con l'utilizzo dei sistemi di trasmissione radio e dei profili conduttivi che vanno ad affiancare i modelli a microinterruttore.

La rete commerciale si espande a livello mondiale, grazie anche alla costante presenza alle manifestazioni di settore.

Il punto di forza della C.C.E. è la capacità di sviluppare prodotti personalizzati per i clienti dall'ideazione alla realizzazione. Per far ciò si affida ad un ufficio tecnico dedicato a ricerca e sviluppo con la possibilità di produrre prototipi 3D in stereolitografia, grazie ai quali è possibile analizzare in anticipo gli oggetti che si andranno a produrre. La C.C.E. è inoltre dotata di una officina interna e di un reparto di stampaggio ad iniezione che le permette di accorciare la filiera di produzione, con grandi vantaggi sulle tempistiche di consegna al cliente. C.C.E. inoltre si affida da sempre a fornitori radicati sul territorio, supportando la creazione di una rete di aziende con vocazione internazionale ed attenzione alle realtà produttive locali.

Le certificazioni alle normative ISO 9001, ISO 14001

ed ISO 45001 non sono solamente questioni burocratiche per l'azienda, ma una conseguenza di una filosofia professionale, che parte dal creare un ambiente di lavoro sicuro, dinamico ed efficiente, per poter garantire prodotti di alto livello ai propri clienti in tutto il mondo. C.C.E. è sensibile alle questioni ambientali e di risparmio energetico, utilizza materiali che non contengono sostanze dannose per la salute, usa energie rinnovabili e preferisce affidarsi ad una rete di fornitori con uguale sensibilità.

Per vocazione aziendale, C.C.E. pensa oggi a quello che il mercato potrà richiedere domani, cercando sempre di favorire la creatività in fase di ideazione di nuovi prodotti che possano migliorare le cose che ci circondano.

EN C.C.E. Costruzioni Chiusure Ermetiche Srl was set up in 1980 to produce automatic door drop-down seals, a crucial accessory for preventing those annoying draughts that get under the door. The usefulness of the application and the state-of-the-art technology applied made the product an immediate success. In 1994 CCE developed a new product, as a result of the experience gained from the production of automatic drop down seals, in particular from the hinge-like model MEC. The product is called STOP, and it uses concepts developed in the door manufacturing industry, transferred to the overhead door industry. The new product uses ponds safety switches, mounted on two aluminum profiles with a hinged movement. In 1996 the Safety Devices sector is founded, fully focused on the production of sensitive edges for protection against impact on automatic openings. The attention to compliance with the latest regulations and the use of premium materials quickly put C.C.E. sensitive edges among the best on the market. Over the years, the renewed STOP model, which is patented, is accompanied by new models to be used on sectional doors and sliding gates.

In recent times new technologies are introduced on the range of products, with the use of radio transmission systems and conductive profiles that join the microswitch models

What makes C.C.E. stand out from the crowd is our ability to develop made-to-measure products for our customers, taking care of everything from the initial concept to final production. We have a dedicated research and development team who can produce 3D stereo-lithographic prototypes, used to study the seals before they go into production. C.C.E. also has its own workshop and an injection moulding division to streamline the whole production process, a significant advantage for the customer when it comes to delivery times.

C.C.E. has always bought its raw materials from companies based throughout Italy, helping create a network of suppliers with an international vocation while supporting local business.

Certification to ISO 9001, ISO 14001 and ISO 18001 Standards is not just a question of paperwork here at C.C.E. but the consequence of our professional philosophy, from creating a safe, dynamic and

efficient workplace, to guaranteeing products of the very highest quality for customers wherever they are in the world.

C.C.E. puts great emphasis on environmental protection and energy savings, using material free of harmful substances, renewable energy while buying from suppliers who adopt the same philosophy. It's the company's vocation for C.C.E. to imagine right now what the market will be looking for in the future, always encouraging creativity in the design of new products that could improve our surroundings.

1980
C.C.E. is founded to produce drop down seals

1991
New factory building

1994
First safety product: model STOP with microswitches

1996
New safety division officially starts

2000
New model: SICURSTOP with microswitches

2006
New building duplicates area

DE Die Bezeichnung C.C.E. steht für den Firmennamen „Costruzioni Chiusure Ermetiche Srl“. Diese Firma wurde im Jahre 1980 gegründet und konstruierte zunächst der automatischer Unterblattichtungen, ein unabdingbares Zubehör zum Schließen des störenden Spalts zwischen der Unterkante des Türblattes und dem Fußboden. Die Zweckmäßigkeit dieser Dichtungen und überraschende technische Lösungen machten C.C.E. rasch erfolgreich.

Neben den automatischen Dichtungen geht 1994 aus der Entwicklung der automatischen Scharnertürdichtung Modell MEC ein neues Produkt hervor. Es heißt STOP und überträgt die im Bereich der Kipptore gesammelte Erfahrung auf Türen. Dabei nutzt es dichte Sicherheitsmikroschalter an zwei Aluminiumprofilen mit Scharnierbewegung.

1996 wird ein Bereich für Sicherheitseinrichtungen gegründet, in dem man sich auf die Herstellung von Kontaktleisten zum Schutz gegen Stöße an automatischen Öffnungen fokussiert.

Die Berücksichtigung der jüngsten Normen und die Verwendung erstklassiger Materialien tragen dazu bei, dass sich die Kontaktleisten von C.C.E. schnell

als die besten auf dem Markt etablieren. Im Laufe der Jahre kommen zum patentierten Modell STOP neue Modelle für Schiebe- und Sektionaltore.

Nach und nach werden die Produkte mit neuen Technologien wie Funksysteme und Leiterprofile ausgestattet, die sich zu den Mikroschaltermodellen gesellen. Das Vertriebsnetz von C.C.E. umspannt den gesamten Globus, auch wegen der ständigen Präsenz auf einschlägigen Branchenveranstaltungen.

Die Stärke von C.C.E. ist das Vermögen, kundenspezifische Produkte von der ersten Idee bis zur Lieferfertigkeit zu entwickeln. Eine der Grundlagen hierfür ist die hauseigene Forschung und Entwicklung. Dort besteht auch die Möglichkeit, 3D-Prototypen in Stereolithographie herzustellen, anhand derer die späteren Produkte im Voraus analysiert werden können. C.C.E. verfügt darüber hinaus über eigene Fertigung und einen eigenen Werkzeugbau für Spritzgussformen. Das verkürzt die Wege bei der Herstellung, was in Bezug auf Auslieferungsfristen einen großen Vorteil bedeutet.

Des Weiteren hat sich C.C.E. schon immer auf Zulieferer aus der Region gestützt. So hat man den Aufbau eines Netzes von Firmen mit internationalen Ruf mit-

getragen und die heimische Industrie unterstützt. Die Zertifizierungen nach den Normen ISO 9001, ISO 14001 und ISO 45001 sind für C.C.E. nicht nur Formalitäten, sondern die logische Folge einer Professionalität, die auf einer sicheren, dynamischen und effizienten Arbeitsweise beruht und den Kunden in aller Welt Produkte auf hohem Niveau garantiert. C.C.E. achtet auch auf den Schutz der Umwelt, das Einsparen von Energie und die Verwendung erneuerbarer Energien sowie von Werkstoffen, die keine gesundheitsschädlichen Substanzen enthalten. Auch der Lieferantenstamm besteht bevorzugt aus Firmen mit gleicher Ausrichtung.

Die Produktpolitik berücksichtigt schon heute die wahrscheinlichen Forderungen der Märkte von morgen und versucht mit Neuentwicklungen immer, die Welt, die uns umgibt, möglichst kreativ zu verbessern.

FR L'entreprise C.C.E. Costruzioni Chiusure Ermetiche Srl a été fondée en 1980, démarrant son activité avec la fabrication de plinthes automatiques, un accessoire indispensable pour éliminer la fente gênante créée entre la porte et le sol. L'utilité de son application et la surprenante technologie appliquée à cet accessoire ont dès le début déterminé le succès de ce produit.

A partir de l'activité des plinthes automatiques, en 1994 naît un nouveau produit développé sur la base du modèle de plinthe à charnière MEC. Le produit s'appelle STOP et est appelé à transmettre l'expérience acquise dans le domaine des portes au secteur des portes basculantes. Il utilise des micro-interrupteurs de sécurité étanches, montés sur deux profilés en aluminium articulés sur un mouvement à charnière. En 1996 la division "Dispositifs de sécurité" est fondée, axée sur la production de bords sensibles pour la protection contre les chocs sur les ouvertures automatiques.

L'attention portée au respect des plus récentes réglementations et l'utilisation de matériaux de première qualité permettent aux palpeurs CCE de s'affirmer rapidement parmi les meilleurs sur le marché. Au fil du

temps, suite au renouvellement du modèle STOP qui a été également brevetée, de nouveaux modèles pour portails coulissants et battants sont ajoutés.

Au cours des dernières années, de nouvelles technologies sont introduites sur la gamme de produits, avec l'utilisation de systèmes de transmission radio intégrés et de caoutchouc conducteur qui rejoignent les modèles à micro-interrupteurs.

Le réseau de vente s'étend au niveau mondial, grâce notamment à une présence constante aux salons de ce secteur.

Le point fort de C.C.E. est sa capacité à développer des produits personnalisés pour les clients depuis la conception jusqu'à la réalisation. Pour ce faire, C.C.E. s'appuie sur un bureau d'études dédié à la recherche et au développement avec la capacité de réaliser des prototypes 3D en stéréolithographie, grâce à laquelle il est possible d'analyser à l'avance les produits qui seront fabriqués. C.C.E. est également pourvue d'un atelier interne et d'un département de moulage par injection qui lui permet de raccourcir la chaîne de production, avec de grands avantages sur les délais de livraison au client.

En outre C.C.E. s'appuie depuis toujours sur des fournisseurs ancrés régionalement, en soutenant la création d'un réseau d'entreprises à vocation internationale et en supportant les fabricants locaux.

Les certifications aux normes ISO 9001, ISO 14001 et ISO 45001 ne relèvent pas seulement des aspects bureaucratiques pour l'entreprise, mais sont une conséquence d'une philosophie professionnelle qui prend racine depuis la création d'un environnement de travail sûr, dynamique et efficace, afin de garantir des produits de haut niveau à ses clients partout dans le monde.

Sensible aux questions d'environnement et aux économies d'énergie, C.C.E. utilise des matériaux qui ne contiennent pas de substances dangereuses pour la santé, exploite les énergies renouvelables et préfère s'appuyer sur un réseau de fournisseurs avec une sensibilité égale.

Par vocation, C.C.E. pense aujourd'hui à ce que le marché pourra demander demain, en essayant toujours de favoriser la créativité en phase de conception de nouveaux produits qui peuvent améliorer les choses qui nous entourent.

2007

Acquisition of mechanical workshop

2009

New product: Radio Communication systems

2012

Green Energy: new photovoltaic system

2013

New model: COMPATTA to become a best seller

2014

New products line with TPE conductive strip

2019

New building to double the factory area

2019

CCE is acquired by Scigno SPA group

2023

ESG Bronze Medal



COMPANY PROFILE

ES C.C.E. Costruzioni Chiusure Ermetiche Srl se fundó en 1980 y empezó su actividad con la realización de juntas automáticas de debajo de la puerta, accesorio imprescindible para eliminar la molesta ranura que queda entre la puerta y el suelo. La utilidad de la aplicación y la tecnología sorprendente que incorpora este accesorio determinaron el éxito inmediato del producto.

Desde el año 1994, al sector de las juntas automáticas se une un nuevo producto que nació de la elaboración del model MEC, una junta automática a bisagra. El nuevo producto es el model STOP, concebido para disfrutar la experiencia en el sector de las puertas también en el sector de los portales basculantes. El funcionamiento cuenta con unos microinterruptores estancos de seguridad instalados sobre dos perfiles en aluminio con movimiento de bisagra. En 1996 se fundó el sector de los dispositivos de seguridad, centrado en la producción de bordes sensibles para proteger las aperturas automáticas contra choques.

La observancia de la normativa más reciente y el uso

de materiales de primera calidad consolidan rápidamente la posición de los bordes sensibles C.C.E. entre los mejores del mercado. Con el paso del tiempo, al renovado y patentado model STOP, se unen unos nuevos modelos para cancelas correderas y portones seccionales.

En los últimos años, con los modelos con microinterruptores estancos, se han introducido nuevas tecnologías en la familia de los dispositivos de seguridad, como el uso de los dispositivos de comunicación inalámbrico y de los perfiles con tecnología conductora. La red comercial se amplía a escala mundial gracias a la presencia constante de la empresa en los eventos del sector.

El punto fuerte de C.C.E. es su capacidad de realizar productos personalizados para los clientes, desde el proyecto hasta la fabricación. Para ello, cuenta con un departamento técnico de I+D que puede producir prototipos 3D mediante estereolitografía, gracias a los cuales es posible analizar los objetos antes de ponerlos en producción. Además, C.C.E. tiene un taller interno y un departamento de moldeo por inyección que le permiten abreviar la cadena de producción,

lo que conlleva una notable reducción del plazo de entrega al cliente.

Por otra parte, C.C.E. colabora desde siempre con proveedores locales afianzados, para respaldar la creación de una red de empresas con vocación internacional pero atentas al tejido productivo local. Las certificaciones según las normas ISO 9001, ISO14001 e ISO 45001 no son meras cuestiones burocráticas para la empresa, sino la consecuencia de una filosofía profesional que empieza con la creación de un entorno de trabajo seguro, dinámico y eficiente, para ofrecer productos de alto nivel a sus clientes en todo el mundo.

C.C.E. es sensible a los problemas medioambientales y de ahorro energético, utiliza materiales que no contienen sustancias nocivas para la salud, usa energías renovables y prefiere colaborar con una red de proveedores que comparten esta sensibilidad. Dada su vocación empresarial, C.C.E. piensa hoy en lo que el mercado va a pedir mañana y siempre intenta promover la creatividad durante la fase de diseño de nuevos productos que mejoren los objetos que nos rodean.



800.000 SAFETY EDGES PRODUCED SINCE THE CREATION OF THE "SAFETY DIVISION"

1994 YEAR OF STARTING THE ACTIVITY

350 AVERAGE DAILY SAFETY EDGES PRODUCTION

272 PRODUCT CODES

100 THEORETICAL LONGEST POSSIBLE LENGTH FOR A SAFETY EDGE

50 KW POWER OF PHOTOVOLTAIC SYSTEM

16 COUNTRIES OF OPERATIONS

13 TYPES OF SAFETY EDGES TO COVER EVERY NEED

8,2 K Ω RESISTOR VALUE FOR CERTIFIED SAFETY EDGES

4 AVERAGE EDGES FOR AN AUTOMATED GATE

1 FACTORY IN ITALY

LEGENDA

APPLICAZIONI / APPLICATIONS APPLICATIONS/ ANWENDUNGEN / APLICACIONES

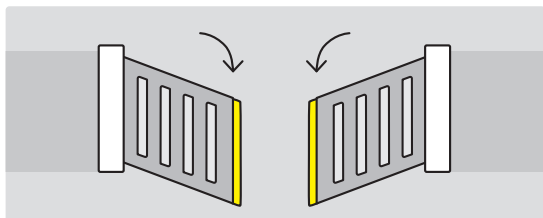

Cancelli a battente.
Swing gates.
Portails battants.
Schwenktore.
Puertas de hoja batiente.

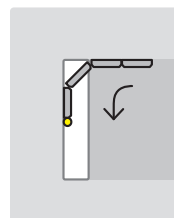

Portoni sezionali.
Sectional doors.
Portes sectionnelles.
Sektionaltore.
Portones seccionales.

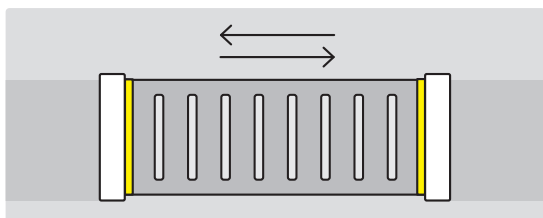

Cancelli scorrevoli.
Sliding gates.
Portails coulissants.
Schiebetore.
Puertas correderas.

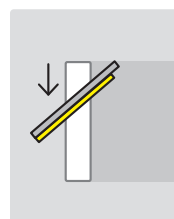

Portoni basculanti.
Overhead doors.
Portes basculantes.
Kiptore.
Portones basculantes.

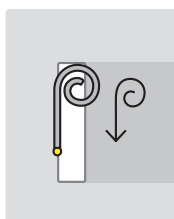

Serrande.
Rolling shutters.
Rideaux.
Rolltore.
Puertas enrollables.

CARATTERISTICHE GENERALI / GENERAL SPECIFICATIONS CARACTERISTIQUES GENERALES / ALLGEMEINE DATEN / CARACTERÍSTICAS GENERALES

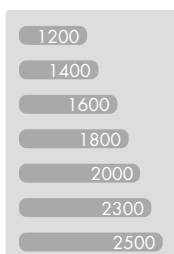

Lunghezze disponibili.
Available lengths.
Longueurs disponibles.
Verfügbare Längen.
Largos disponibles.

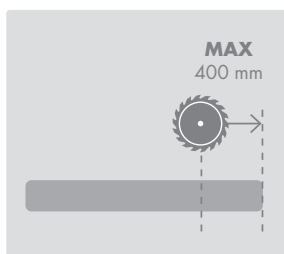

Accorciabilità massima.
Maximum trimming lengths.
Raccourcissement maximum.
Maximale Ablängbarkeit.
Recorte máximo posible.



Temperatura di esercizio.
Working temperature.
Température de fonctionnement.
Betriebstemperatur.
Temperatura de funcionamiento.



Grado di protezione microinterruttori.
Microswitch degree of protection.
Indice de protection des micro interrupteurs.
Schutzart Mikroschalter.
Grado de protección de los microinterruptores.

CARATTERISTICHE MODELLO / MODEL SPECIFICATIONS CARACTERISTIQUES PRODUITS / MODELLSPEZIFISCHE DATEN CARACTERÍSTICAS DEL MODELO



Contatto normalmente aperto (N.A.)
Normally open contact (N.O.)
 Contact normalement ouvert (N.O.)
Schließerkontakt (N.O.)
 Contacto normalmente abierto (N. A.)



Contatto normalmente chiuso (N.C.)
Normally closed contact (N.C.)
 Contact normalement fermé (N.F.)
Öffnerkontakt (N.C.)
 Contacto normalmente cerrado (N. C.)



Dispositivo di sicurezza resistivo.
Resistive safety edge.
 Dispositif de sécurité résistif.
Widerstands-Schutzvorrichtung.
 Dispositivo de seguridad resistivo.



Reagisce al contatto con la costa.
Reacts to contact with safety edge.
 Réagit au contact avec le palpeur.
Reagiert bei Kontakteistenberührung.
 Reacciona al contacto con la banda de seguridad.



Portata massima in campo aperto.
Open field maximum range.
 Portée maximum en champ libre.
Maximale Reichweite ungestört.
 Alcance máximo en campo abierto.



Rileva l'ostacolo senza contatto.
Detects the obstacle before contact.
 Détecte l'obstacle sans contact.
Erfasst das Hindernis ohne Kontakt.
 Detecta al obstáculo sin contacto.



Comanda fino a ... TX.
Controls up to ... Tx.
 Contrôle jusqu'à ... TX.
Betätigung von bis zu ... Sendern.
 Controla hasta ... TX.



Canali di trasmissione.
Nr. of transmission channels.
 Canaux de transmission.
Übertragungskanäle.
 Canales de transmisión.



Collegamento in serie di più coste conduttive.
Series wiring of several conductive safety edges.
 Installation de plusieurs palpeurs conductif en série.
Reihenschaltung mehrerer Kontakteiste
 Conexión en serie de mas dispositivos CND.



Frequenza di trasmissione.
Transmission frequency.
 Fréquence de transmission.
Übertragungsfrequenz.
 Frecuencia de transmisión.



Alimentazione 12/24 v AC/DC.
12/24 v AC/DC Power supply.
 Alimentation 12/24 v AC/DC.
Betriebsspannung 12/24V AC/DC.
 Alimentación: 12/24 VCA/VCC.



Alimentazione con batterie al litio 1,5 V o 3,6V.
1,5V or 3,6V lithium batteries transmitter power supply.
 Alimentation par piles au lithium 1,5 V ou 3,6V.
Stromversorgung durch Lithiumakkus 1,5 V oder 3,6V.
 Alimentación con pilas de litio de 1,5 V o 3,6V.



Certificato IMQ.
Certificated by IMQ.
 Certificat IMQ.
Zertifiziert durch IMQ als Prüfinstitut.
 Certificación IMQ.

OPZIONI / OPTIONALS OPTIONS / OPTIONEN / OPCIONES



Scheda di controllo.
Control boards.
 Carte de contrôle.
Steuerkarte.
 Tarjeta de control.



Coppia trasmettitore + ricevitore wireless.
Wireless receiver&transmitter.
 Couple transmetteur et récepteur sans fil.
Funk-Sender-/Empfängeranlage.
 Conjunto de transmisor + receptor inalámbrico.



Ricevitore wireless.
Wireless receiver.
 Récepteur sans fil.
Funkempfänger.
 Receptor inalámbrico.

CERTIFICATIONS

COMPANY CERTIFICATION



Management System
 ISO 9001:2015
 ISO 14001:2015
 ISO 45001:2018



www.tuv.com
 ID 9105070522

IMQ CR 466 DM CERTIFICATION (CAT.2 PL "D")

IMQ N. IMQ CR 466 DM Rev. 3

CERTIFICATO DI ESAME CE DEL TIPO
 EC TYPE EXAMINATION CERTIFICATE

Questo certificato è emesso da IMQ in qualità di Organismo Notificato per la Direttiva 2004/42/CE - Normativa Identificativa 2021 - per il controllo di sicurezza dei prodotti per la sicurezza 2004/42/CE - Identificativo numero 001.

Questo documento è composto da 3 pagine comprendenti i campi e i dati pertinenti a questo prodotto e questo sistema.

2021-09-23
 Data emissione
 2021-09-23
 Data scadenza
 2021-09-23
 Data di rinnovo

IMQ

IMQ ALLEGATO/ANNEX N. IMQ CR 466 DM Rev. 3

REFERIMENTO PRATICA IMQ / IMQ Reference: 20A00002 - 20AR00166 - MA21-0002873

Marca / Trade mark: CCE
 Modello / Model: CCE SICUR (SCHED2)

TITOLO DESCRIZIONE - CATEGORIA, POSIZIONE COMPONENTI TECNICI DA CONTROLLARE / TITLE DESCRIPTION - CATEGORY, POSITION COMPONENTS TO BE EXAMINED

Componenti / Components	Specifiche Tecniche / Technical Specifications
Scheda di controllo (serie commerciali) / Safety control board (commercial series)	EN 12978-2003(A): 2009 EN ISO 13849-1: 2015 EN ISO 13849-2: 2012
Scheda di controllo (serie commerciali) / Control board (commercial series)	EN 12978-2003(A): 2009 EN ISO 13849-1: 2015 EN ISO 13849-2: 2012
RECEIVER E RICEVITORI RACCOMANDATI / RECOMMENDED RECEIVER AND RECEIVERS	EN 12978-2003(A): 2009 EN ISO 13849-1: 2015 EN ISO 13849-2: 2012

EMMISSIONE CORRENTE / Current issue: 2021-09-23
 PRIMA EMISSIONE / First issue: 2021-09-23
 DATA SCADENZA / Expiry date: 2021-09-23

IMQ

IMQ ALLEGATO/ANNEX N. IMQ CR 466 DM Rev. 3

TITOLO DESCRIZIONE - CATEGORIA, POSIZIONE COMPONENTI TECNICI DA CONTROLLARE / TITLE DESCRIPTION - CATEGORY, POSITION COMPONENTS TO BE EXAMINED

Componenti / Components	Specifiche Tecniche / Technical Specifications
Scheda di controllo (serie commerciali) / Safety control board (commercial series)	EN 12978-2003(A): 2009 EN ISO 13849-1: 2015 EN ISO 13849-2: 2012
Scheda di controllo (serie commerciali) / Control board (commercial series)	EN 12978-2003(A): 2009 EN ISO 13849-1: 2015 EN ISO 13849-2: 2012
RECEIVER E RICEVITORI RACCOMANDATI / RECOMMENDED RECEIVER AND RECEIVERS	EN 12978-2003(A): 2009 EN ISO 13849-1: 2015 EN ISO 13849-2: 2012

EMMISSIONE CORRENTE / Current issue: 2021-09-23
 PRIMA EMISSIONE / First issue: 2021-09-23
 DATA SCADENZA / Expiry date: 2021-09-23

IMQ

IMQ CT 496 DM CERTIFICATION (CAT.3 PL "E")

IMQ N. IMQ CT 496 DM Rev. 3

CERTIFICATO DI ESAME CE DEL TIPO
 EC TYPE EXAMINATION CERTIFICATE

Questo certificato è emesso da IMQ in qualità di Organismo Notificato per la Direttiva 2004/42/CE - Normativa Identificativa 2021 - per il controllo di sicurezza dei prodotti per la sicurezza 2004/42/CE - Identificativo numero 001.

Questo documento è composto da 3 pagine comprendenti i campi e i dati pertinenti a questo prodotto e questo sistema.

2021-09-23
 Data emissione
 2021-09-23
 Data scadenza
 2021-09-23
 Data di rinnovo

IMQ

IMQ ALLEGATO/ANNEX N. IMQ CT 496 DM Rev. 3

REFERIMENTO PRATICA IMQ / IMQ Reference: 20A00002

Marca / Trade mark: CCE
 Modello / Model: CCE SICUR (SCHED2)

TITOLO DESCRIZIONE - CATEGORIA, POSIZIONE COMPONENTI TECNICI DA CONTROLLARE / TITLE DESCRIPTION - CATEGORY, POSITION COMPONENTS TO BE EXAMINED

Componenti / Components	Specifiche Tecniche / Technical Specifications
Scheda di controllo (serie commerciali) / Safety control board (commercial series)	EN 12978-2003(A): 2009 EN ISO 13849-1: 2015 EN ISO 13849-2: 2012
Scheda di controllo (serie commerciali) / Control board (commercial series)	EN 12978-2003(A): 2009 EN ISO 13849-1: 2015 EN ISO 13849-2: 2012
RECEIVER E RICEVITORI RACCOMANDATI / RECOMMENDED RECEIVER AND RECEIVERS	EN 12978-2003(A): 2009 EN ISO 13849-1: 2015 EN ISO 13849-2: 2012

EMMISSIONE CORRENTE / Current issue: 2021-09-23
 PRIMA EMISSIONE / First issue: 2021-09-23
 DATA SCADENZA / Expiry date: 2021-09-23

IMQ

SAFETY DIVISION

Bordi sensibili di varie dimensioni e caratteristiche tecniche, per utilizzo su tutti i tipi di aperture automatiche.

Safety Edges of various dimensions and technical features, to be used in all kind of automatic closures.

Bords sensibles de diverses dimensions et spécifications pour l'utilisation sur tous types d'ouvertures automatiques.

Kontaktleisten verschiedener Abmessungen und mit verschiedenen technischen Eigenschaften für die Verwendung an allen Arten automatischer Tore.

Bordes sensibles de distintos tamaños y características técnicas instalables en todo tipo de aperturas automáticas.



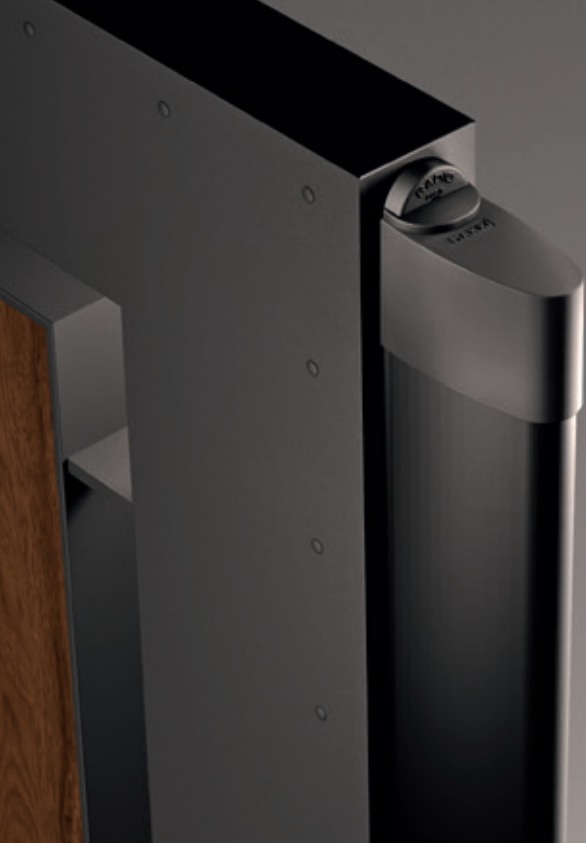



MAXXI CND

Safety contact edges for
large sliding gates

 Il pezzo forte della famiglia di bordi sensibili con tecnologia conduttiva, MAXXI CND è progettato per l'utilizzo su cancelli scorrevoli molto pesanti. Utilizza un profilo conduttivo in TPE coestruso al suo interno che garantisce risposte rapide ad ogni impatto, ed è accorciabile infinitamente.

 *The showpiece of safety contact edges family, MAXXI CND has been designed to be used on heavy and large sliding gates. It features an inner TPE conductive profile which guarantees quick response to every impact, the bar can be trimmed at will.*

 Au sommet de la famille des bords sensibles avec technologie conductive, MAXXI CND est conçue pour une utilisation sur les portails coulissants très lourds. Elle utilise à l'intérieur un profil conducteur coextrudé en TPE qui garantit des réponses rapides à chaque impact, elle est raccourcissable infiniment.

 *MAXXI CND ist das Highlight der Kontaktleistenreihe mit Leitertechnologie und für sehr schwere Schiebetore konzipiert. Sie verwendet ein innenliegendes koextrudiertes TPE-Leitprofil, das sofort auf jedes Anstoßen reagiert, stufenlos ablängbar.*

 El punto fuerte de la familia de bordes sensibles con tecnología conductora es MAXXI CND, que ha sido diseñado para el uso en puertas correderas muy pesadas. Utiliza un perfil conductor de TPE coextruido en su interior que garantiza respuestas rápidas en cada impacto, puede recortarse ilimitadamente.



**TOTAL
SAFETY**

Safety guaranteed on all
border's length, including
endcaps.

APPLICATIONS

SIZES

LENGTHS AND TRIMMING

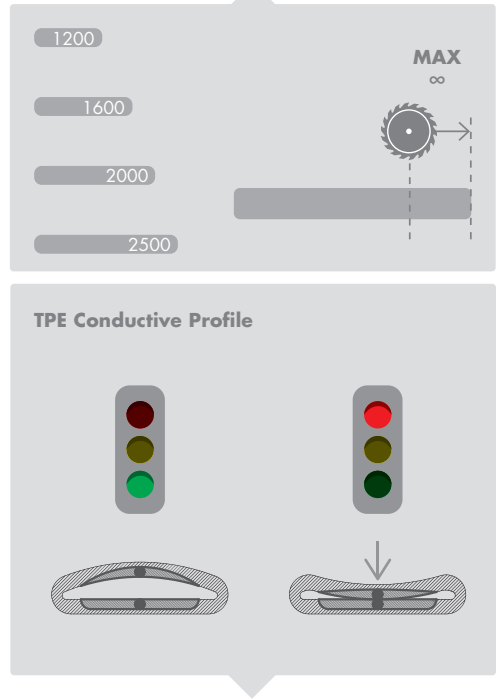
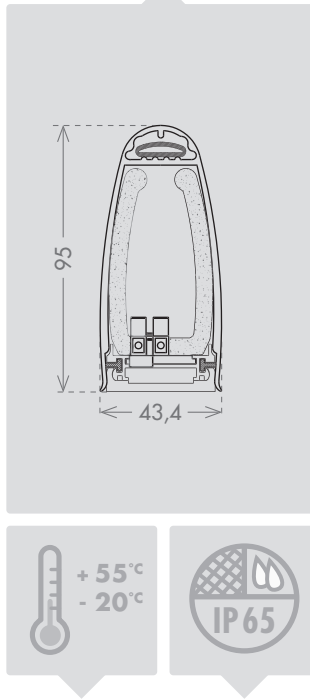
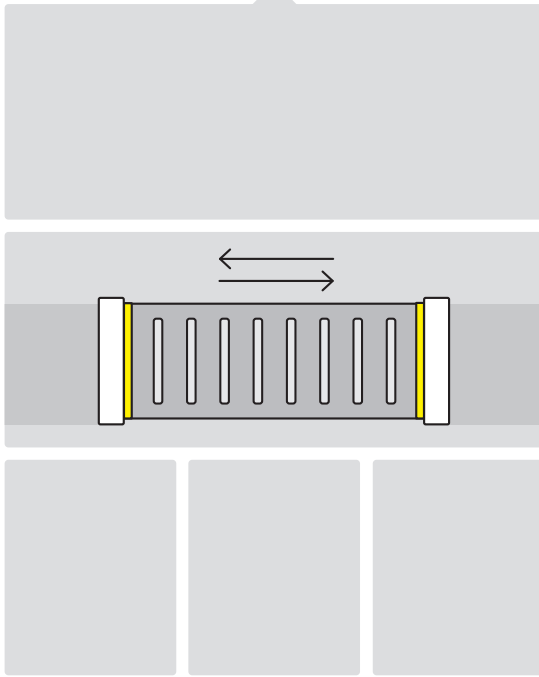

TEMPERATURE

DEVICE
IP RATING

TECHNOLOGY

MAXXI CND

code: **CEMACN00NO**



MAXXI CND LINK CABLE

code: **CEMACNLCNO**



MAXXI CND LINK TERMINAL

code: **CEMACNLTNO**



MAXXI CND RADIO EVO

code: **CEMACNRENO**







COMPATTA CND

Safety contact edges with compact size.

 Facile da installare ed accorciabile infinitamente, COMPATTA CND sfrutta la tecnologia conduttiva in un bordo sensibile piccolo e discreto. Il dispositivo di sicurezza garantisce una risposta rapida agli impatti su tutta la lunghezza della struttura.

 Easy to install, COMPATTA CND can be cut down at will. It uses an inner TPE conductive profile on a small and discreet body, which guarantees quick response to every impact.

 Facile à installer et raccourcissable infiniment, COMPATTA CND exploite la technologie conductive dans un format de bord sensible petit et discret. Le dispositif de sécurité assure une réponse rapide aux impacts sur toute la longueur de sa structure.

 COMPATTA CND ist einfach zu montieren, stufenlos ablängbar und nutzt in einer kleinen und diskreten Kontaktleiste die Leitertechnologie. Die Sicherheitseinrichtung garantiert das schnelle Reagieren auf alle Stöße entlang der gesamten Struktur.

 Fácil de instalar y recortable ilimitadamente, COMPATTA CND incorpora tecnología conductora en un borde sensible pequeño y discreto. El dispositivo de seguridad garantiza una respuesta rápida a los choques a todo lo largo de la estructura.



**TOTAL
SAFETY**

Safety guaranteed on all border's length, including endcaps.

APPLICATIONS

SIZES

LENGTHS AND TRIMMING

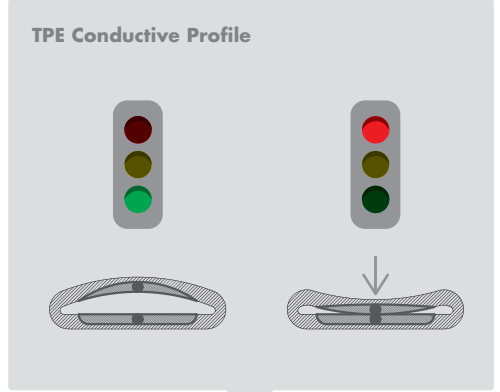
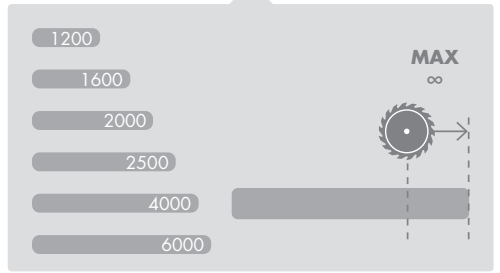
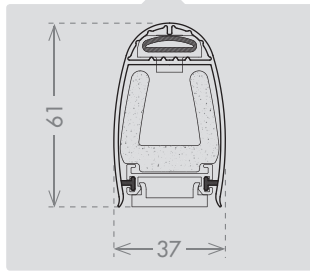
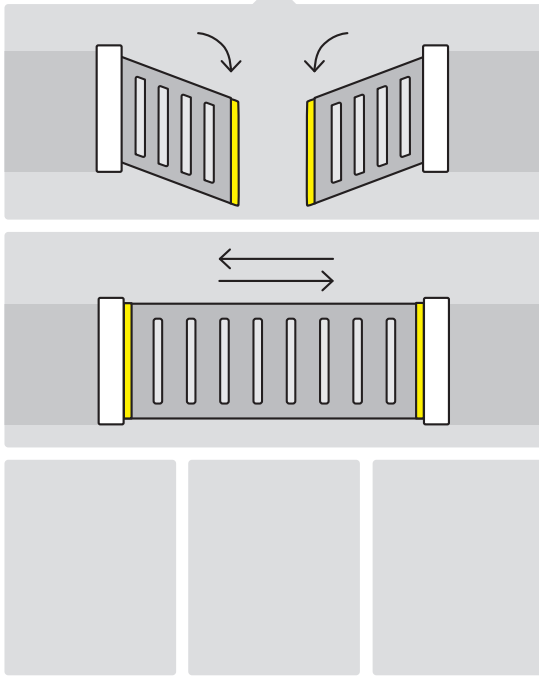

TEMPERATURE

DEVICE IP RATING

TECHNOLOGY

COMPATTA CND

code: **CECOCN00N0**



COMPATTA CND LINK CABLE

code: **CECOCNLCN0**



COMPATTA CND LINK TERMINAL

code: **CECOCNLTN0**



COMPATTA CND RADIO EVO

code: **CECOCNRENO**







MINI CND

Safety contact edges with compact size.

 Il modello MINI CND è stato progettato per l'utilizzo sui cancelli a battente, installato sul perimetro del cancello sia in posizione verticale che in posizione orizzontale. Utilizza un profilo conduttivo in TPE coestruso al suo interno che garantisce risposte rapide ad ogni impatto ed è accorciabile infinitamente.

 Model MINI CND is designed to be used on swing gates and installed on the perimeter of the gate both in vertical position and in horizontal position. It features an inner TPE conductive profile which guarantees quick response to every impact, the bar can be cut down at will at any length.

 Le modèle MINI CND a été pensé pour être installée sur le périmètre du portail aussi bien en position verticale qu'horizontale. Il utilise un caoutchouc conducteur en TPE co-extrudé qui garantit un temps de réponse rapide à l'impact et est recoupable indéfiniment.

 Das Modell MINI CND wurde für Drehtore ausgelegt und wird umlaufend montiert. Ein intern verlaufendes koextrudiertes Leiterprofil aus TPE ist beliebig ablängbar und gewährleistet das sofortige Ansprechen bei jeder Berührung.

 El model MINI CND fue ideado para ser utilizado en cancelas con bisagra, y puede ser instalado sobre el perímetro de la cancela tanto en vertical y en horizontal. Usa un perfil conductivo con TPE coextruida al interior para garantir una reacción rápida a cada choque y puede ser acortado infinitamente.



**TOTAL
SAFETY**

Safety guaranteed on all border's length, including endcaps.

APPLICATIONS

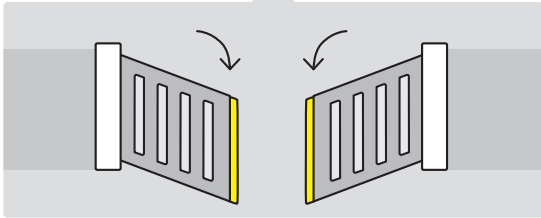

SIZES

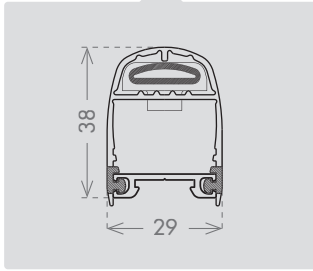

LENGTHS AND TRIMMING

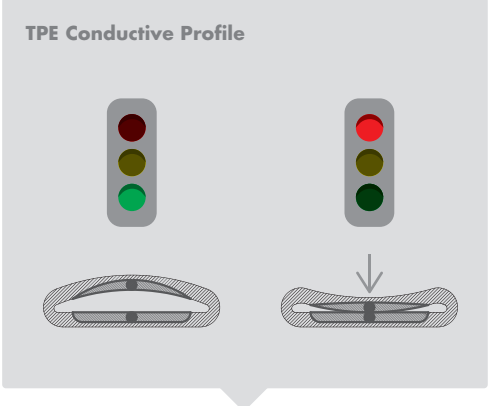
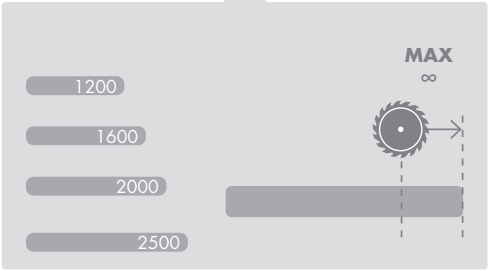

TEMPERATURE

DEVICE
IP RATING

TECHNOLOGY

MINI CND

code: **CEMICN00GO**







MINI ROLL CND

Safety contact edges for swing gates.

 Il modello MINI ROLL CND è stato progettato per l'utilizzo sui cancelli a battente, installato sul perimetro del cancello sia in posizione verticale che in posizione orizzontale. Utilizza un profilo conduttivo in TPE coestruso al suo interno che garantisce risposte rapide ad ogni impatto ed è accorciabile infinitamente. MINI ROLL CND è disponibile in comodi kit, pensati per poter comporre diversi spezzoni di lunghezza a piacimento.

 Model MINI ROLL CND is designed to be used on swing gates and installed on the perimeter of the gate both in vertical position and in horizontal position. It features an inner TPE conductive profile which guarantees quick response to every impact, the bar can be cut down at will at any length. MINI ROLL CND is available in a handy kit which includes all the necessary items to produce several segments of different lengths.

 Le modèle MINI ROLL CND a été pensé pour être installée sur le périmètre du portail aussi bien en position verticale qu'horizontale. Il utilise un caoutchouc conducteur en TPE co-extrudé qui garantit un temps de réponse rapide à l'impact et est recoupable indéfiniment. MINI ROLL CND Il est disponible en kit pratiques et conçus pour réaliser plusieurs palpeurs de longueurs variées.

 Das Modell MINI ROLL CND wurde für Drehtore ausgelegt und wird umlaufend montiert. Ein intern verlaufendes koextrudiertes Leiterprofil aus TPE ist beliebig ablängbar und gewährleistet das sofortige Ansprechen bei jeder Berührung. MINI ROLL CND Erhältlich als zweckmäßiges Set für das Zusammensetzen in beliebig lange Teile.

 El model MINI ROLL CND fue ideado para ser utilizado en cancelas con bisagra, y puede ser instalado sobre el perimetro de la cancela tanto en vertical y en horizontal. Usa un perfil conduttivo con TPE coextruida al interior para garantir una reacción rapida a cada choque y puede ser acortado infinitamente. MINI ROLL CND Es sidponible en kit ideado para construir piezas de diferente longitud.

 **TOTAL
SAFETY**

Safety guaranteed on all border's length, including endcaps.

APPLICATIONS

SIZES

LENGTHS AND TRIMMING

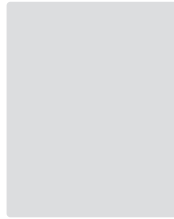
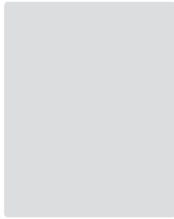
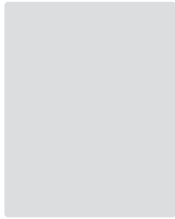
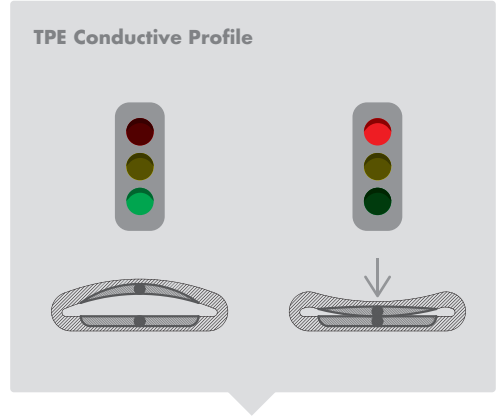
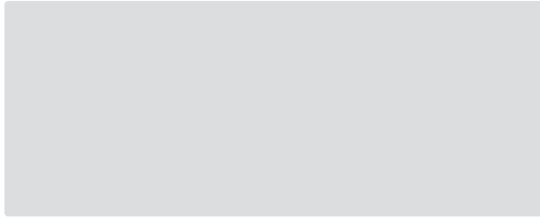
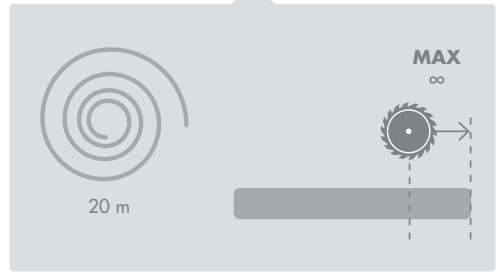
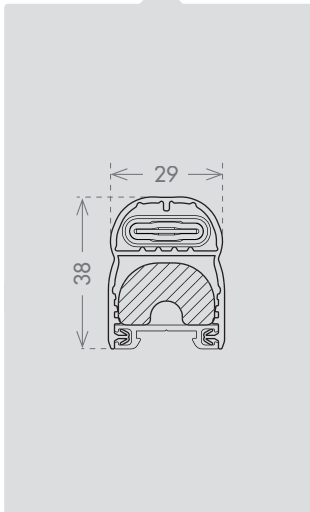
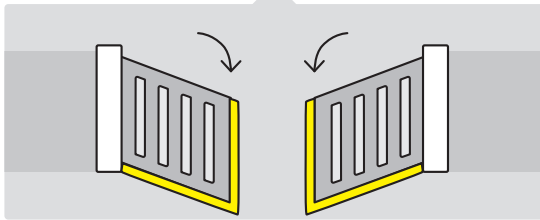

TEMPERATURE

DEVICE
IP RATING

TECHNOLOGY

MINI ROLL CND

code: **CEKITCND0024 + CEKITCND0022 + CEKITCND0025A**

8,2 kΩ

IMQ

ESTIMATE FOR 10 KIT OF 2MT

OPT 1
pg 40

OPT 2
pg 37

ACCESSORY:

code: **CESCHACC0024**



code: **CEKITCND0023**







MINI LIP CND

Safety contact edges for sectional doors.

 Il modello MINI LIP CND è l'ideale per l'applicazione in orizzontale su portoni sezionali e serrande. Grazie ai suoi tappi laterali con i fermi inclusi è molto semplice da regolare in fase di installazione. E' disponibile in comodi kit, pensati per poter comporre diversi spezzoni di lunghezza a piacimento.

 Model MINI LIP CND is the ideal horizontal application for sectional doors and rolling shutters. It features lateral endcaps with in-built adjusters for a perfect setup during installation. It's available in a handy kit which includes all the necessary items to produce several segments of different lengths.

 Le modèle MINI LIP CND est l'idéal pour une application horizontale sur portes sectionnelles et portes rideaux. Grâce à ses embouts latéraux avec fixation incluse, il est très facile à régler en phase d'installation. Il est disponible en kit pratiques et conçus pour réaliser plusieurs palpeurs de longueurs variées.

 Das Modell MINI LIP CND ist ideal für die horizontale Anwendung an Sektionaltoren und Rollläden. Dank seiner seitlichen Kappen und den dazugehörigen Feststelleinrichtungen ist seine Regulierung beim Anbringen sehr einfach. Erhältlich als zweckmäßiges Set für das Zusammensetzen in beliebig lange Teile.

 El model MINI LIP CND es ideal para una instalación horizontal sobre portones seccionales y cierres metálicos. Su tapones laterales con paradas incluidas permiten un ajuste muy fácil durante la instalación. Es sidponible en kit ideado para construir piezas de diferente longitud.



**TOTAL
SAFETY**

Safety guaranteed on all border's lenght, including endcaps.

APPLICATIONS

SIZES

LENGTHS AND TRIMMING

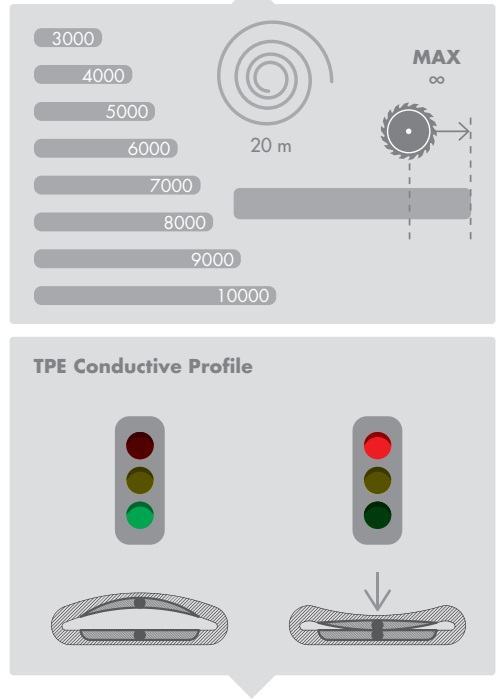
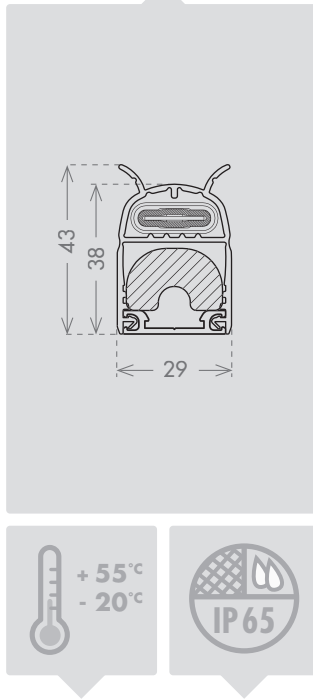
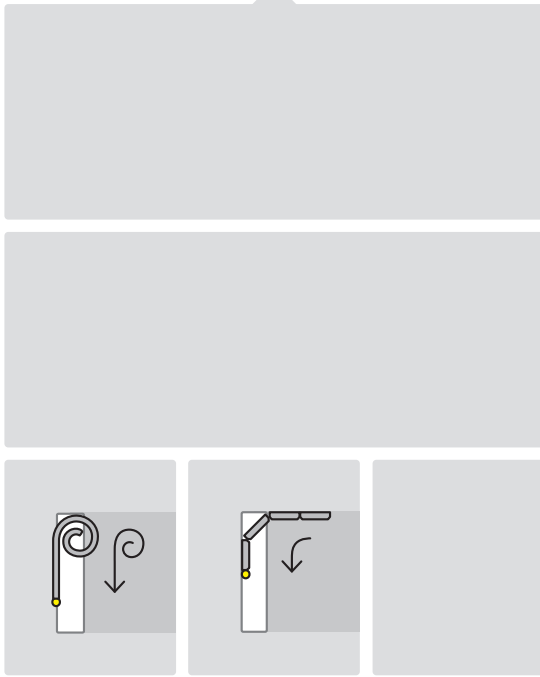

TEMPERATURE

DEVICE IP RATING

TECHNOLOGY

MINI LIP CND KIT

code: **CEKITCND0018 + CEKITCND0017 + CEKITCND0019A**

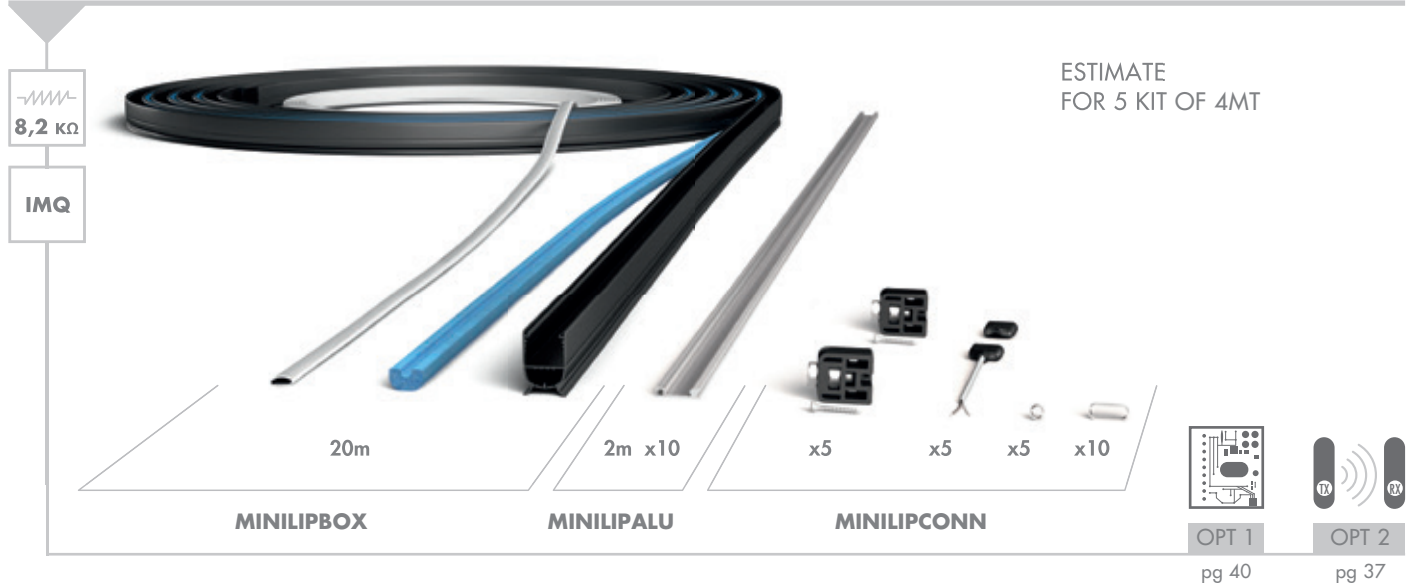

ACCESSORY:

code: **CESCHACC0024**



MINI LIP CND

code: **CEMLCNOON**

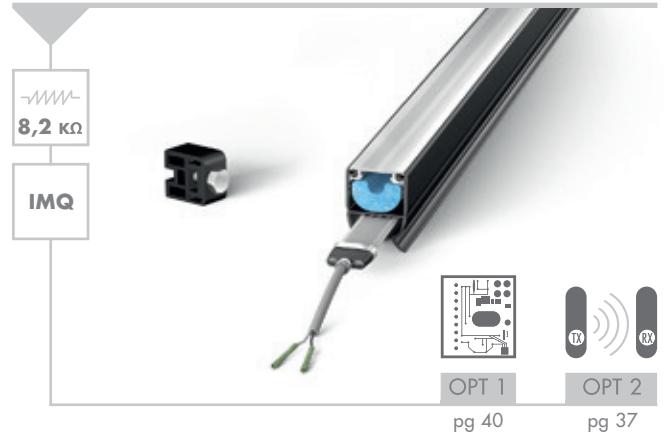





PICCOLA CND

Safety contact edges for gates and industrial use.

 Il modello PICCOLA CND può essere utilizzato sia sui cancelli a battente, per proteggere il punto di cesoimento tra l'anta del cancello e lo stipite, sia nell'ambito industriale come bordo di sicurezza sui macchinari. E' disponibile sia in barre di misura finita che in comodi kit, pensati per poter comporre diversi spezzoni di lunghezza a piacimento.

 Model PICCOLA CND can be used on swing gates to protect the shearing point between the pillar and the gate leaf. It also can be used on industrial machinery as a safety edge for perimeter safety. It's available in bars or in a kit which includes all the necessary items to produce several segments of different lengths.

 Le modèle PICCOLA CND peut être utilisé aussi bien sur les portails battants pour protéger le point de cisaillement entre le vantail et le pilier que dans un environnement industriel en tant que bord de sécurité pour machines. Il est disponible soit en longueurs à mesure soit en kit conçu pour la réalisation de plusieurs palpeurs de longueurs variées.

 Das Modell PICCOLA CND kann sowohl auf Drehtoren angewendet werden, um den Scherpunkt zwischen dem Torblatt und dem Pfosten zu schützen, als auch im Industriebereich als Sicherheitsleiste an Maschinen. Erhältlich sowohl als fertige Stäbe als auch als bequeme Sets für das Zusammensetzen in beliebig lange Teile.

 El model PICCOLA CND puede ser utilizado tanto en cancelas con bisagra para proteger el espacio entre la hoja y el marco de la cancela, y tambien en aplicaciones industriales como dispositivo de seguridad en las maquinarias. Es disponible tanto en barras de misura definida, y en kit ideado para construir piezas de diferente longitud.



**TOTAL
SAFETY**

Safety guaranteed on all border's length, including endcaps.

APPLICATIONS

SIZES

LENGTHS AND TRIMMING

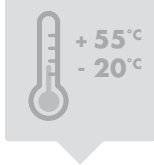
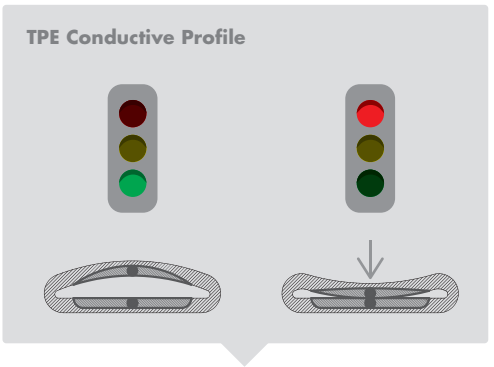
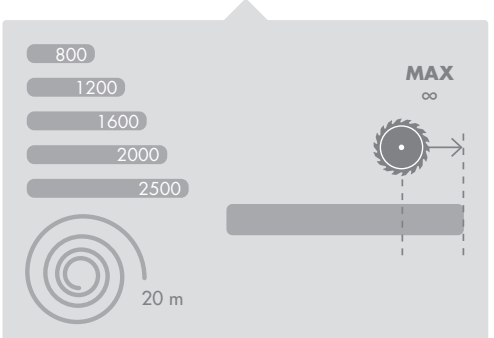
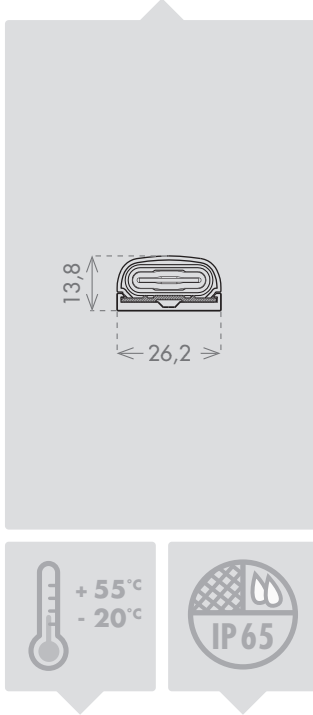
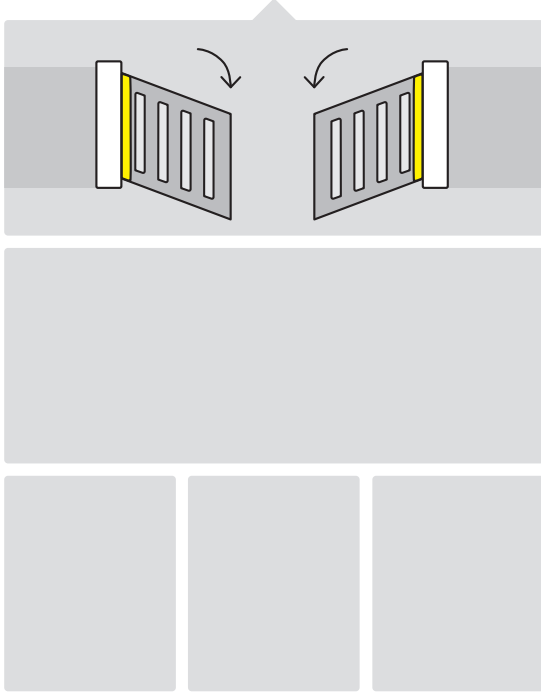

TEMPERATURE

DEVICE
IP RATING

TECHNOLOGY

PICCOLA CND KIT

code: **CEKITCND0002 + CEKITCND0001 + CEKITCND0003A**

8,2 kΩ

IMQ

PICCOBOX PICCOALU PICCOCONN

ESTIMATE
FOR 10 KIT OF 2MT

OPT 1
pg 40

OPT 2
pg 37

ACCESSORY:

code: **CESCHACC0024**



PICCOLA CND

code: **CEPICNO0NO**

8,2 kΩ

IMQ

OPT 1
pg 40

OPT 2
pg 37





COMPATTA

Small size, great performances

 Ideale per cancelli scorrevoli leggeri e a battente, COMPATTA è un bordo sensibile piccolo e discreto, facile da installare ed accorciare. Utilizza un sistema a microinterruttori stagni con risposta rapida agli impatti su tutta la lunghezza della struttura.

 Ideal for light sliding gates or swing gates, COMPATTA is a small and discreet safety edge, easy to install and cut down to size. It uses IP67 microswitches with quick response to every impact on all structure's length.

 Idéale pour les portails coulissants légers ou battants, COMPATTA est un bord sensible petit et discret, facile à installer et à raccourcir. Il utilise un système à micro interrupteurs étanches avec une réponse rapide aux impacts sur toute la longueur de la structure.

 COMPATTA ist eine kleine und diskrete Kontaktleiste, die einfach zu verlegen und abzulängen ist. Sie eignet sich ideal für Schwenk- und Schiebetore. Sie arbeitet mit einem System dichter und schnell auf jeden Stoß an jeder Stelle des Profils reagierender Mikroschalter.

 Ideal para puertas correderas ligeras y de hoja batiente, COMPATTA es un borde sensible pequeño y discreto, fácil de instalar y recortar. Utiliza un sistema de microinterruptores estancos que ofrecen una respuesta rápida a los choques a lo largo de toda la estructura.



**TOTAL
SAFETY**

Safety guaranteed on all border's length, including endcaps.

APPLICATIONS

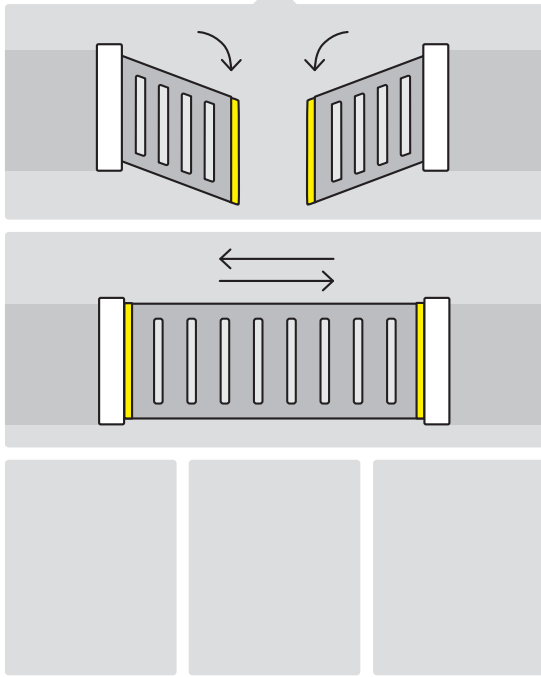

SIZES

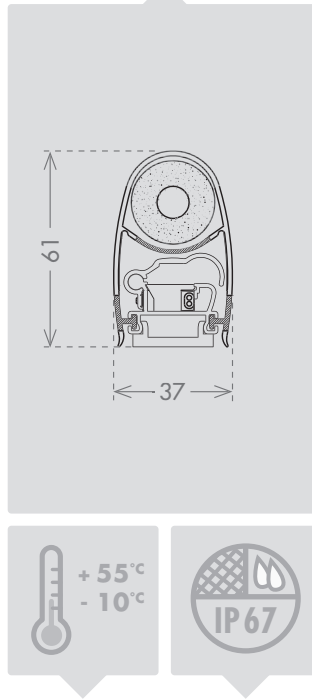

TEMPERATURE MICROSWITCH
IP RATING

LENGTHS AND TRIMMING

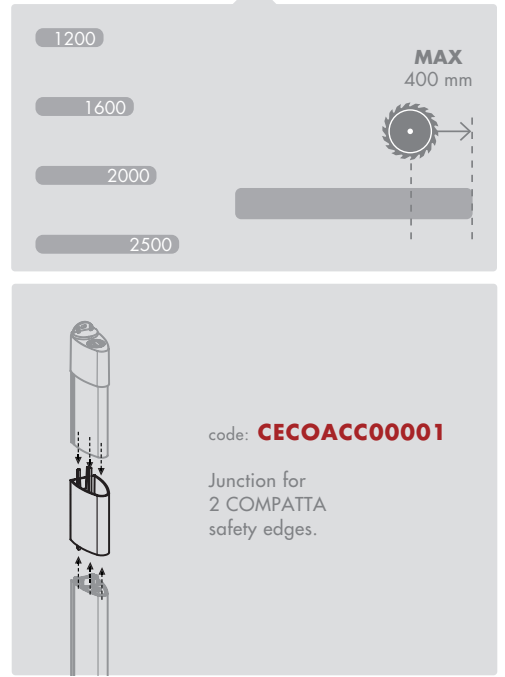

code: **CECOACC0001**

Junction for
2 COMPATTA
safety edges.

COMPATTA PROTO

code: **CECOPR00G0**







SICURSTOP

A great classic in Safety Edges.

 SICURSTOP è il più classico dei bordi sensibili per cancelli scorrevoli e portoni sezionali ed uno dei più utilizzati. Struttura in alluminio e gomma triestrusa, utilizza un sistema a microinterruttori stagni. E' disponibile anche nella versione per portoni sezionali (KITSEZ).

 SICURSTOP is a true classic of safety edges for sliding gates and one of our bestsellers. Made of an aluminum base and tri-extruded rubber, uses an IP67 microswitch systems. It also has a version for sectional doors (KITSEZ).

 SICURSTOP est le plus classique des bords sensibles pour portails coulissants et portes sectionnelles et un des plus utilisés. Doté d'une structure en aluminium et caoutchouc tri extrudé, il utilise un système à micro interrupteurs étanches. Il est également disponible avec transmetteur sans fil intégré et dans une version pour portes sectionnelles (KITSEZ).

 SICURSTOP ist der Klassiker unter den Kontakteleisten für Schiebe- und Sektionaltore und Verkaufsschlager. Die Struktur besteht aus Aluminium und dreifach extrudiertem Gummi und nutzt ein dichtes Mikroschaltersystem. Es gibt sie auch in der Ausführung für Sektionaltore (KITSEZ).

 Entre los bordes sensibles para puertas correderas y portones seccionales, SICURSTOP es el más clásico y uno de los más usados. Tiene una estructura de aluminio y caucho coextruido tricapa, y utiliza un sistema de microinterruptores estancos. También está disponible con transmisor inalámbrico integrado y en versión para portones seccionales (KITSEZ).

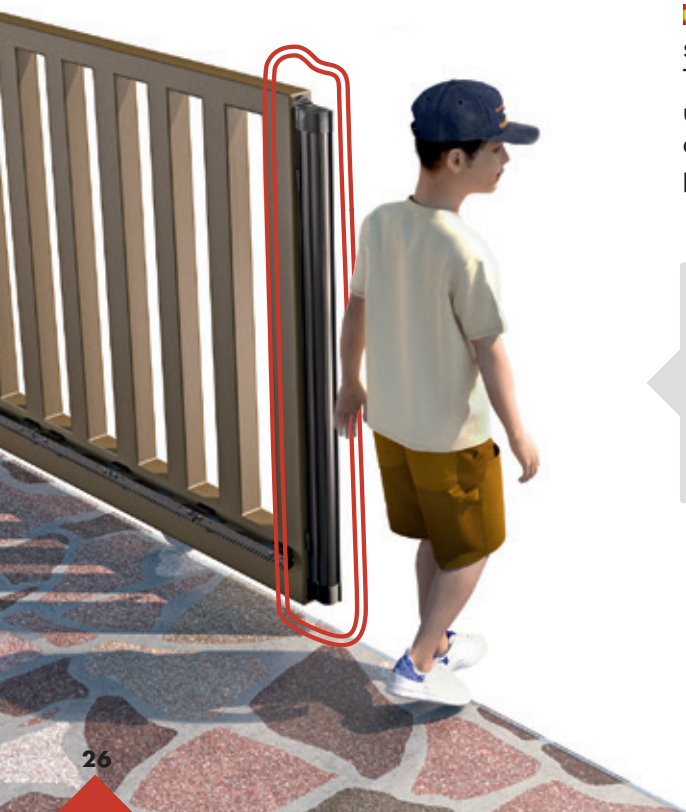

TOTAL SAFETY

Safety guaranteed on all border's length, including endcaps.

APPLICATIONS

SIZES

LENGTHS AND TRIMMING

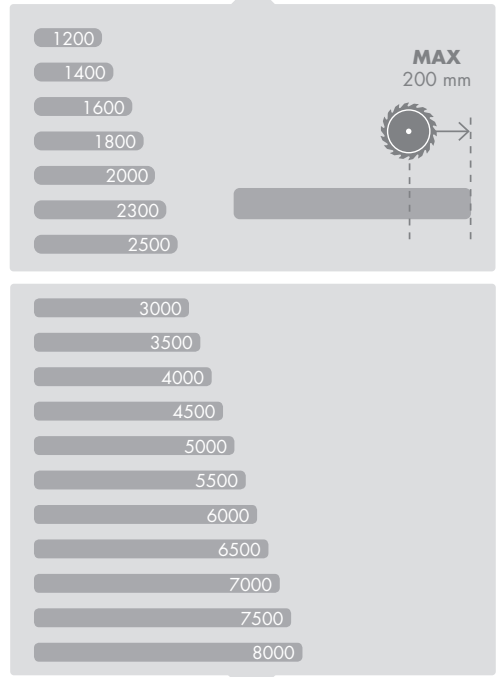
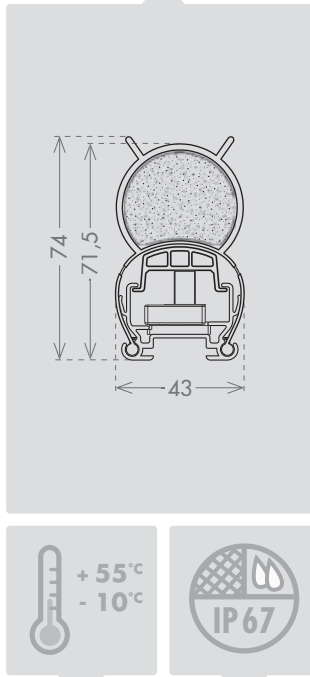
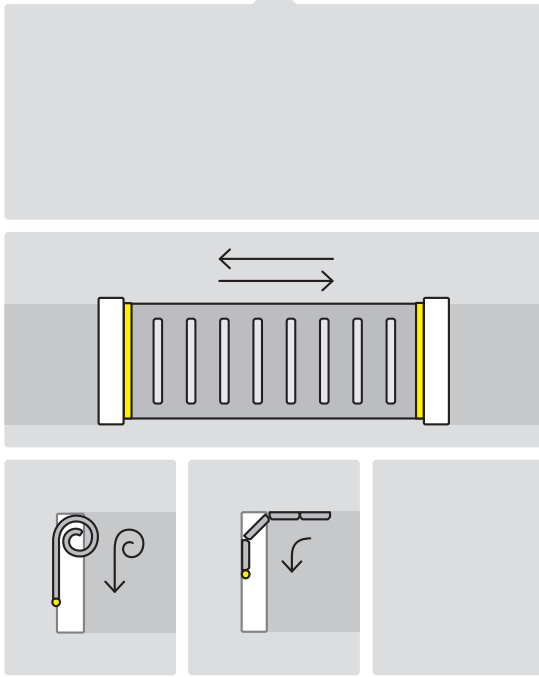

TEMPERATURE

MICROSWITCH
IP RATING

SECTIONAL DOORS KIT
ASK FOR INFO: INFO@CCE.IT

SICURSTOP CONTROL

code: **CESICTOONO**

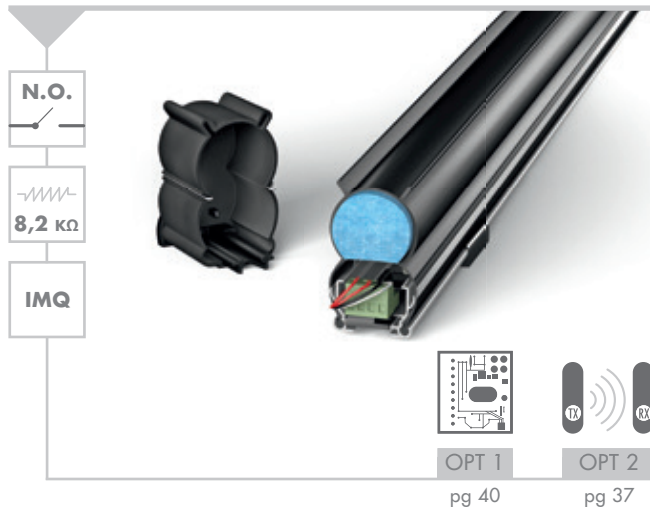

SICURSTOP PROTO

code: **CESIPROONO**



SICURSTOP CONTROL RADIO EVO

code: **CESICTRENO**



SICURSTOP PROTO RADIO EVO

code: **CESIPRENO**







STOP

From overhead doors to industrial application, a versatile solution.

 Un grande classico nel settore della sicurezza, STOP è un bordo sensibile in alluminio molto versatile, può essere utilizzato su porte basculanti, serrande ed in campi industriali. Utilizza microinterruttori stagni ed è dotato di una serie di accessori, inclusa la gomma maggiorata "Tartaruga", che permettono varie combinazioni ed utilizzi.

 Another great classic in safety, STOP is a very versatile aluminum safety edge. It can be used on overhead doors, rolling shutters and also in the industrial field. It uses IP67 microswitches and a variety of accessories is available, including the oversized rubber "Tartaruga", which allows many combinations of use.

 Grand classique dans le secteur de la sécurité, STOP est un bord sensible en aluminium très polyvalent, il peut être appliqué sur les portes basculantes, les rideaux et dans le champs industriel. Il utilise des micro interrupteurs étanches et peut recevoir une série d'accessoires, incluant un caoutchouc majoré "Tartaruga", qui permettent différentes combinaisons et utilisations.

 STOP ist ein wahrhafter Klassiker auf dem Gebiet des Anwenderschutzes: eine sehr vielseitige Kontaktleiste aus Aluminium, welche sich für Kipptore, Rolltore und Industrieanwendungen eignet. Die Leiste arbeitet mit dichten Mikroschaltern und ist mit einer Reihe von Zusatzausstattungen wie etwa weiterentwickeltem Gummi namens „Tartaruga“ versehen, wodurch verschiedene Kombinationen und Anwendungen möglich sind.

 El borde sensible STOP de aluminio es muy versátil y es todo un clásico en el sector de la seguridad; se puede usar en puertas basculantes, puertas enrollables y en campos industriales. Utiliza microinterruptores estancos y está dotado de una serie de accesorios (incluida la goma de gran tamaño "Tartaruga") que ofrecen distintas combinaciones y usos.

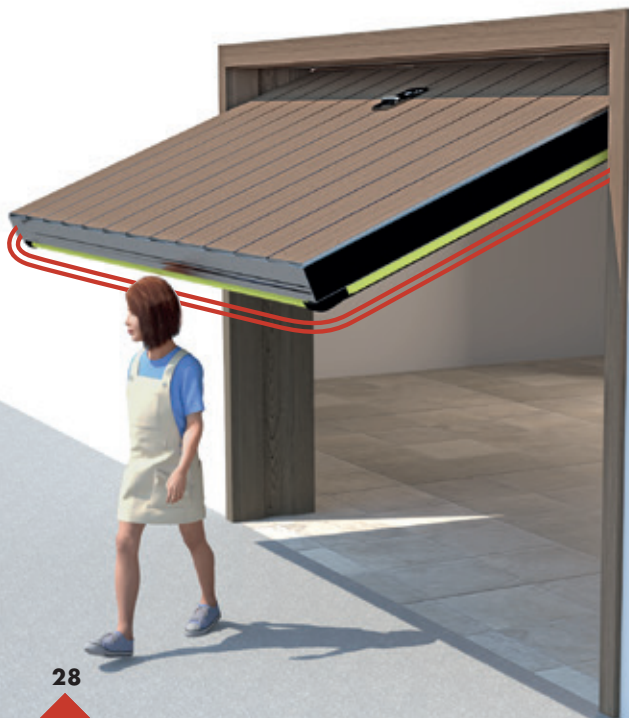

TOTAL SAFETY

Safety guaranteed on all border's length, including endcaps.

APPLICATIONS

SIZES

LENGTHS AND TRIMMING

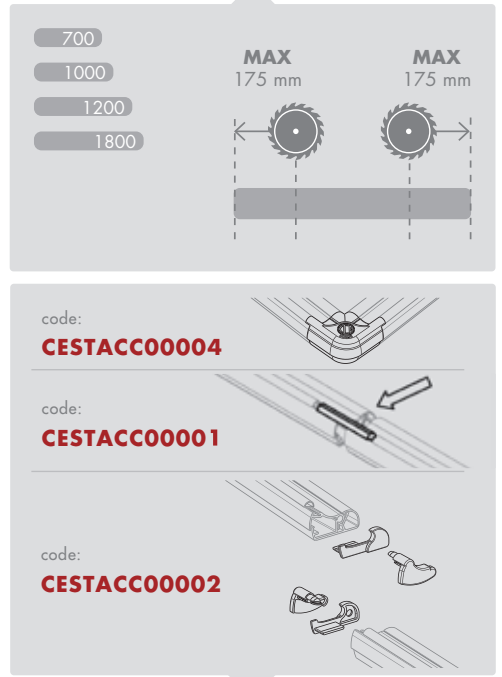
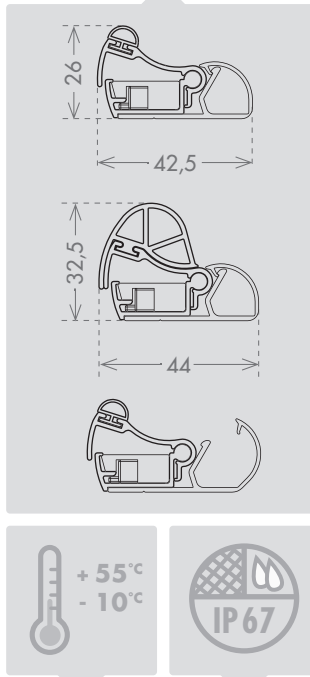
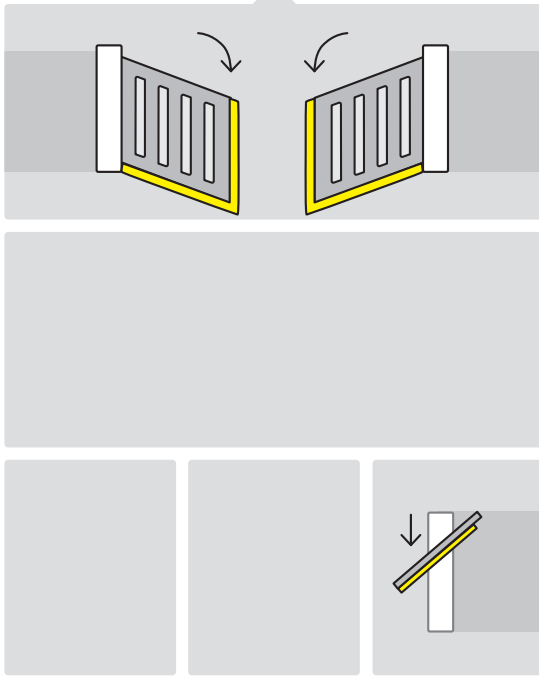

TEMPERATURE
MICROSWITCH
IP RATING

ACCESSORIES

STOP CONTROL

code: **CESTCT00YO (Y/B) - CESTCT00NO (B)**

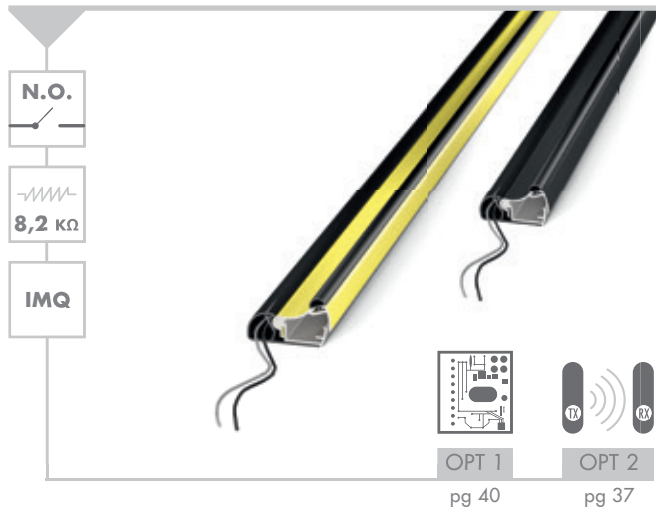

STOP TARTARUGA CONTROL

code: **CESTCTTAYO (Y/B) - CESTCTTANO (B)**



STOP PROTO

code: **CESTPROOYO (Y/B) - CESTPROONO (B)**



STOP TARTARUGA PROTO

code: **CESTPRTAYO (Y/B) - CESTPRTANO (B)**







TECNOSTOP

Light but strong.

 **TECNOSTOP** è un bordo sensibile interamente in plastica coestrusa, adatto per l'utilizzo su basculanti e portoni a battente. Leggero e facile da installare, utilizza microinterruttori stagni ed è particolarmente indicato per uso all'esterno, data la sua grande resistenza all'acqua.

 **TECNOSTOP** is a safety edge entirely made in co-extruded plastic, suitable to be fitted on overhead doors and swing gates. Light and easy to install, uses IP67 microswitches and is particularly suggested for external use due to its high water resistance.

 **TECNOSTOP** est un bord sensible intégralement en plastique co extrudé, adapté pour une utilisation sur les portes basculantes et les portillons. Léger et facile à installer, il utilise des micro interrupteurs étanches et est particulièrement indiqué pour un usage externe étant donné sa grande résistance à l'eau.

 **TECNOSTOP** ist eine vollständig aus koextruiertem Kunststoff bestehende Kontaktleiste, die besonders für Kipp- und Schwenktore ausgelegt ist. Sie ist leicht und einfach zu verlegen, arbeitet mit dichten Mikroschaltern und eignet sich wegen ihrer besonderen Wasserbeständigkeit besonders für den Gebrauch im Außenbereich.

 **TECNOSTOP** es un borde sensible realizado completamente con plástico coextruido, adecuado para el uso en puertas basculantes y portones de hoja batiente. Ligero y fácil de instalar, utiliza microinterruptores estancos y es especialmente idóneo para el uso en exteriores, gracias a su excelente resistencia al agua.



APPLICATIONS

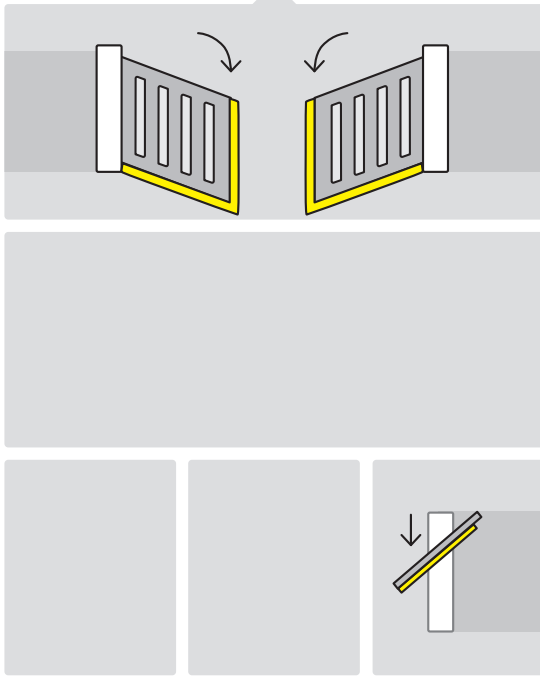

SIZES

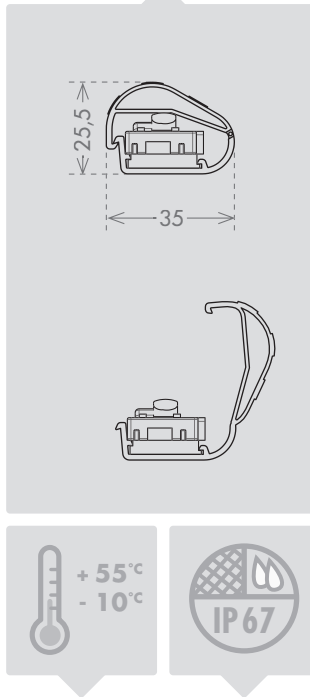

LENGTHS AND TRIMMING

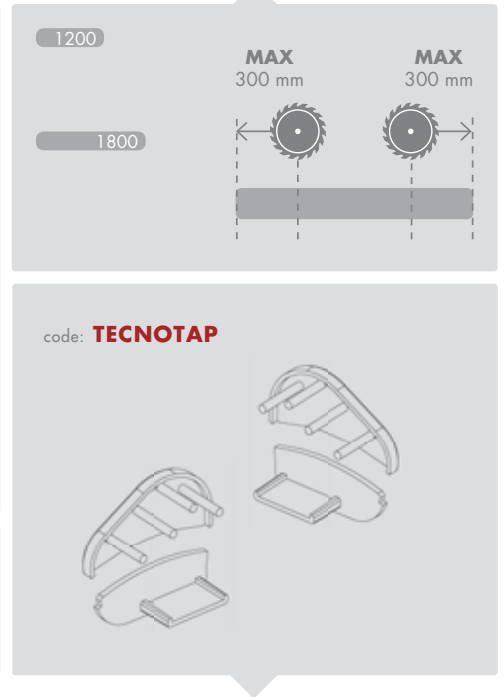

TEMPERATURE
MICROSWITCH
IP RATING

ACCESSORY

TECNOSTOP CONTROL

code: **CETECTO00YO (Y/B) - CETECTO00GO (G/B)**

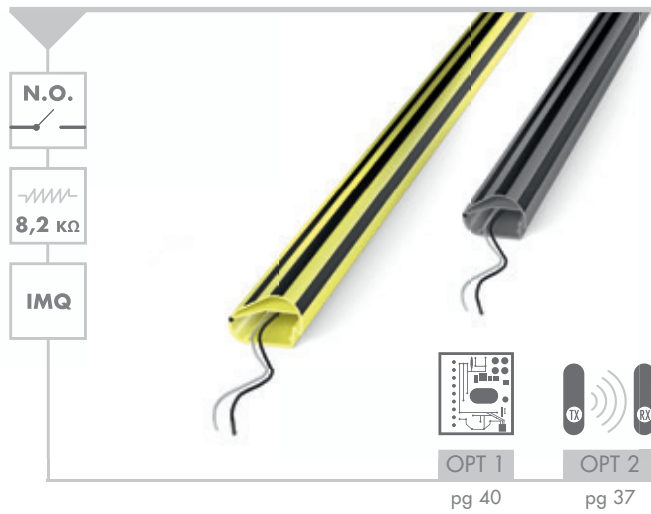

TECNOSTOP PROTO

code: **CETEPRO00YO (Y/B) - CETEPRO00GO (G/B)**

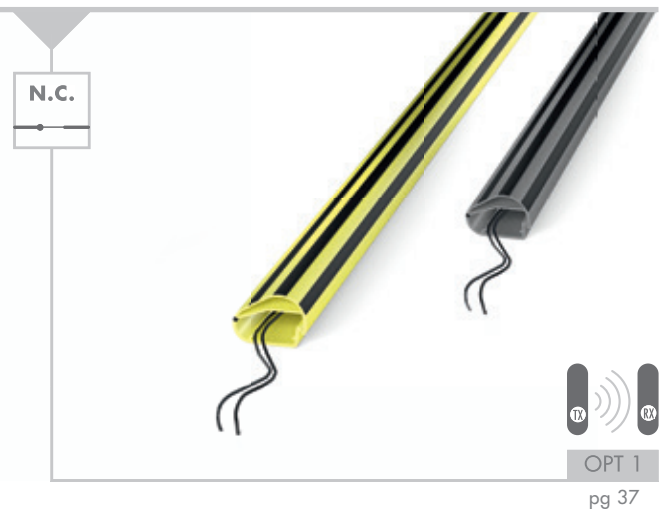





PASSIVA

Bumpers, for increased safety.

 I bordi sensibili per cancelli scorrevoli CCE sono disponibili anche in versione senza elettronica interna. PASSIVA è una linea di paraurti di diverse dimensioni da utilizzare sui cancelli scorrevoli come accessorio per attutire eventuali impatti.

 CCE rubber edges for sliding gates are also available without inner electronics. PASSIVA is a family of bumpers of different dimensions, to be used on sliding gates as an accessory to prevent dangerous impacts.

 Les bords sensibles CCE pour portails coulissants sont également disponibles en version sans électronique. PASSIVA est une ligne de pare-chocs de différentes tailles pour une utilisation sur les portails coulissants comme accessoire servant à amortir les impacts.

 Alle Kontaktleisten für Schiebetore von C.C.E. sind auch in einer Ausführung ohne integrierte Elektronik erhältlich. PASSIVA ist eine Reihe von Klemmschutzvorrichtungen mit verschiedensten Abmessungen, welche als Zubehör für Schiebetore verwendbar sind, um dort Stöße abzdämpfen.

 Los bordes sensibles para puertas correderas de C.C.E. también están disponibles en versión sin sistema electrónico interno. PASSIVA es una línea de parachoques de varios tamaños que se instala en puertas correderas como accesorio para amortiguar posibles choques.



APPLICATIONS

LENGTHS AND TRIMMING

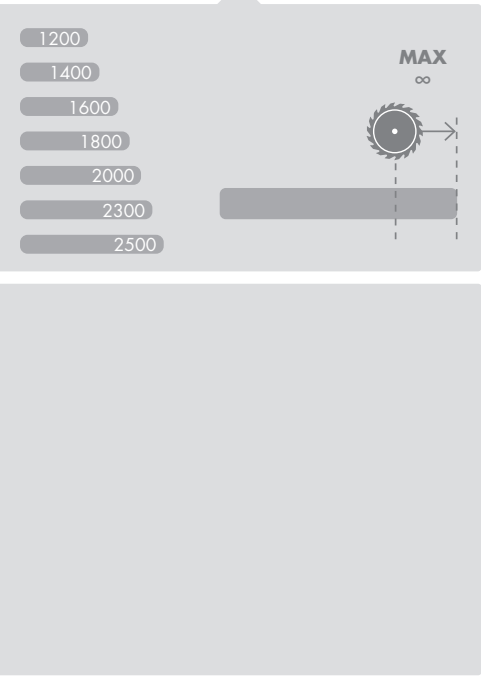
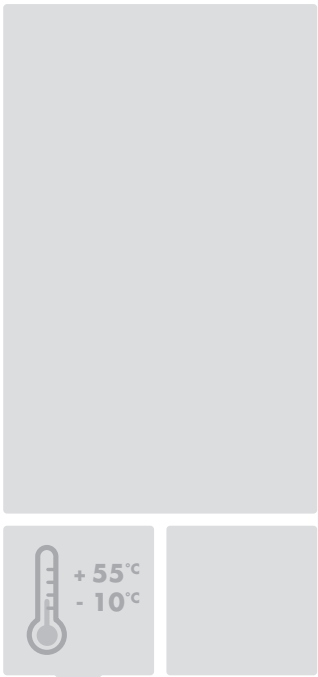
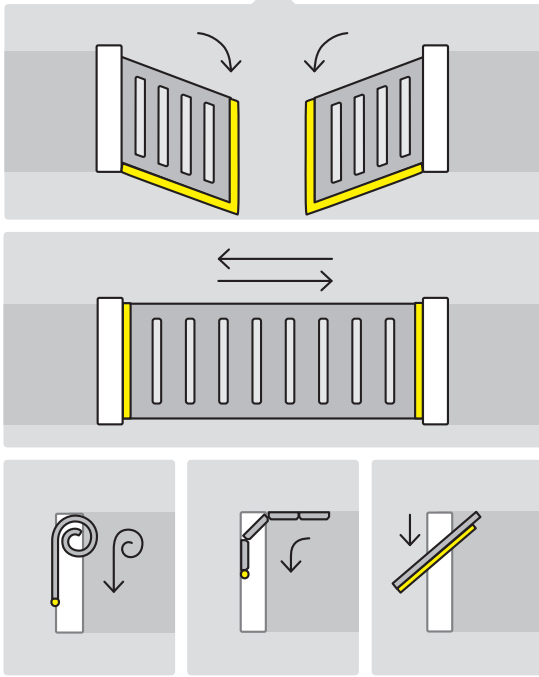

TEMPERATURE

MINI ROLL PASSIVA

code: **CEKITCND0028 + CEKITCND0022 + CEKITCND0027A**

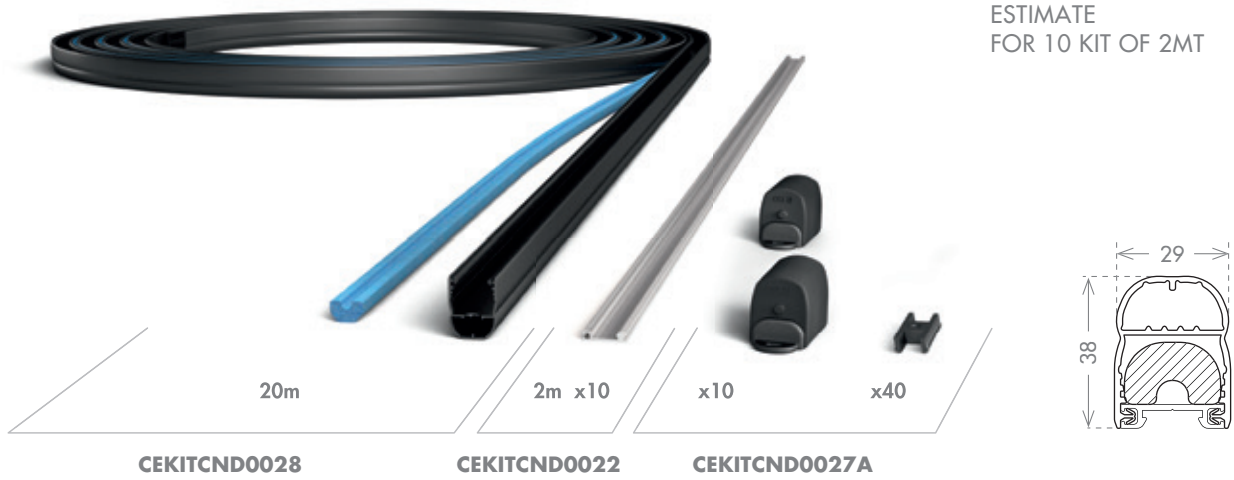

COMPATTA PASSIVA

code: **CECOPA00GO**

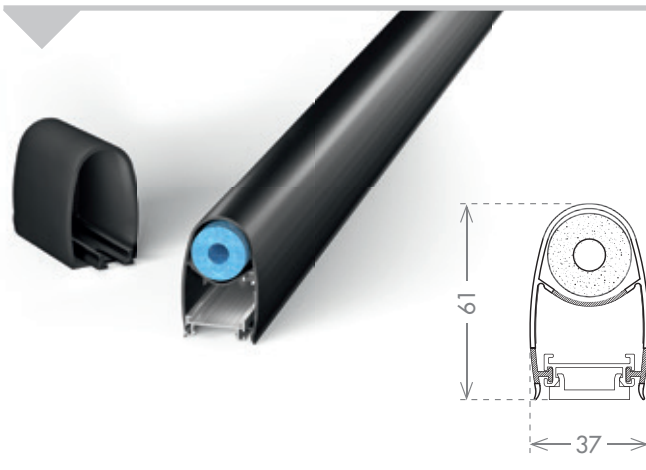

ACCESSORIES

La linea di ACCESSORI, raggruppa una gamma completa di dispositivi e sistemi per aiutare e semplificare l'installazione delle automazioni.

ACCESSORIES line consists of a group of devices designed to help and ease automation fitting.

La ligne D'ACCESSOIRES regroupe une gamme complète de dispositifs et de systèmes pour faciliter et simplifier l'installation des ouvertures automatiques.

Die Produktreihe ACCESSORI ist eine vollständige Reihe von Vorrichtungen und Systemen zur Unterstützung und Vereinfachung beim Aufbau automatisierter Produktionsanlagen.

La línea de ACCESSORIOS contiene una gama completa de dispositivos y sistemas que contribuyen y simplifican la instalación de los automatismos







RADIO EVO

Wireless transmission systems for safety edges.



 RADIO EVO è un dispositivo di comunicazione wireless per la gestione in sicurezza di uno o più bordi sensibili. Applicabile a tutti i tipi di bordo, risparmia laboriosi cablaggi.

 RADIO EVO is a bidirectional wireless communication system used to manage one or more safety edges. The system is easy to install without any laborious wiring on the moving parts.

 RADIO EVO est un dispositif de communication sans fil pour la gestion en sécurité d'un ou plusieurs bords sensibles. Il est applicable à tous types de bords sensibles et évite les câblages laborieux.

 RADIO EVO ist eine Funkanlage für das sichere Ansteuern einer oder mehrerer Kontakteisten. Sie ist für alle Arten von Kontakteisten verwendbar und erspart arbeitsaufwändiges Verkabeln.

 RADIO EVO es un dispositivo de comunicación inalámbrico que controla uno o varios bordes sensibles con toda seguridad. Instalable en todo tipo de bordes, evita el engorro del cableado.



APPLICATIONS

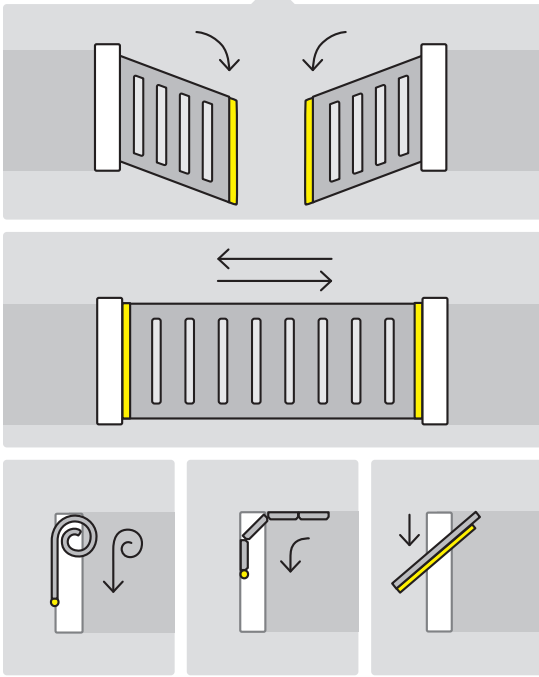

SIZES

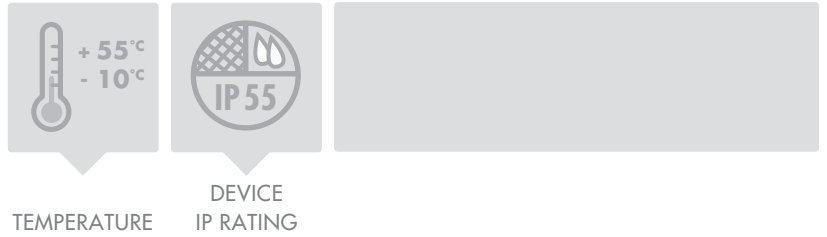
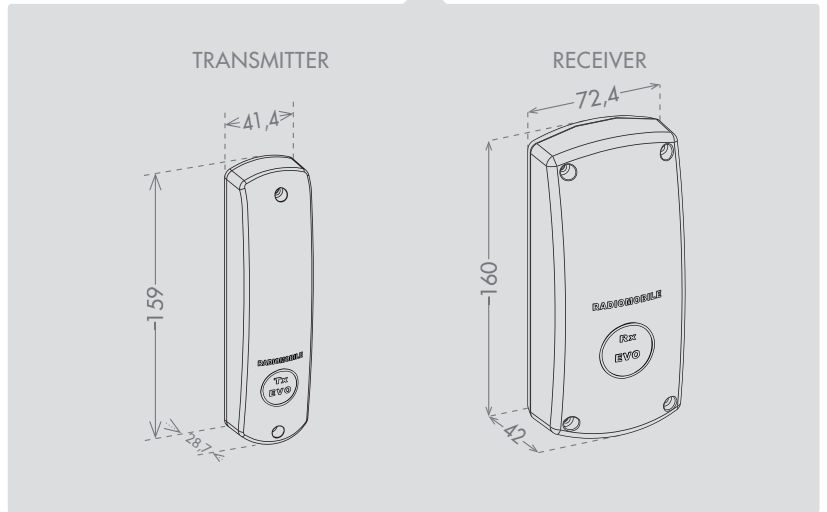

RADIO EVO RX 868MHZ

code: **CESCHACC0002A**

RADIO EVO TX 868MHZ

code: **CESCHACC0007A**

2 channels

12/24 volt

TX RX TX

TX RX TX

2 channels

2x 1,5v LITHIUM

TX

50 m

- * Disponibile anche in versione integrata nei modelli MAXXI CND, COMPATTA CND, SICURSTOP
- * Built-in version available on MAXXI CND, COMPATTA CND, SICURSTOP



RADIO EVO GHOST

Wireless transmission systems for safety edges.
Detects obstacles before impact.



IT RADIO EVO GHOST è un rivoluzionario dispositivo di comunicazione wireless per la gestione in sicurezza di uno o più bordi sensibili. Il sistema rileva gli ostacoli prima che avvenga l'impatto ed interviene garantendo massima sicurezza.

UK RADIO EVO GHOST is a revolutionary bidirectional wireless communication system used to manage one or more safety edges. The system detects obstacles before the impact and intervenes promptly guaranteeing maximum safety.

FR RADIO EVO GHOST est un dispositif révolutionnaire de communication sans fil pour la gestion d'un ou plusieurs bords sensibles en toute sécurité. Le système relève les obstacles avant qu'ait lieu l'impact et intervient en garantissant une sécurité maximale.

DE RADIO EVO GHOST ist eine revolutionäre Funkanlage für das sichere Ansteuern von ein oder mehreren Kontaktleisten. Das System erfasst Hindernisse schon vor dem Aufprall, spricht an und garantiert somit höchste Sicherheit.

ES RADIO EVO GHOST es un revolucionario dispositivo de comunicación inalámbrico que controla uno o varios bordes sensibles con toda seguridad. El sistema detecta a los obstáculos antes del impacto y se acciona rápidamente garantizando la máxima seguridad.



APPLICATIONS

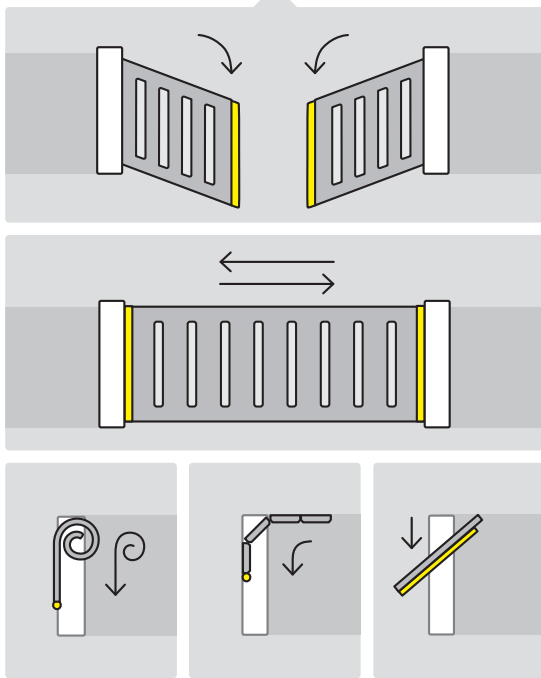

SIZES

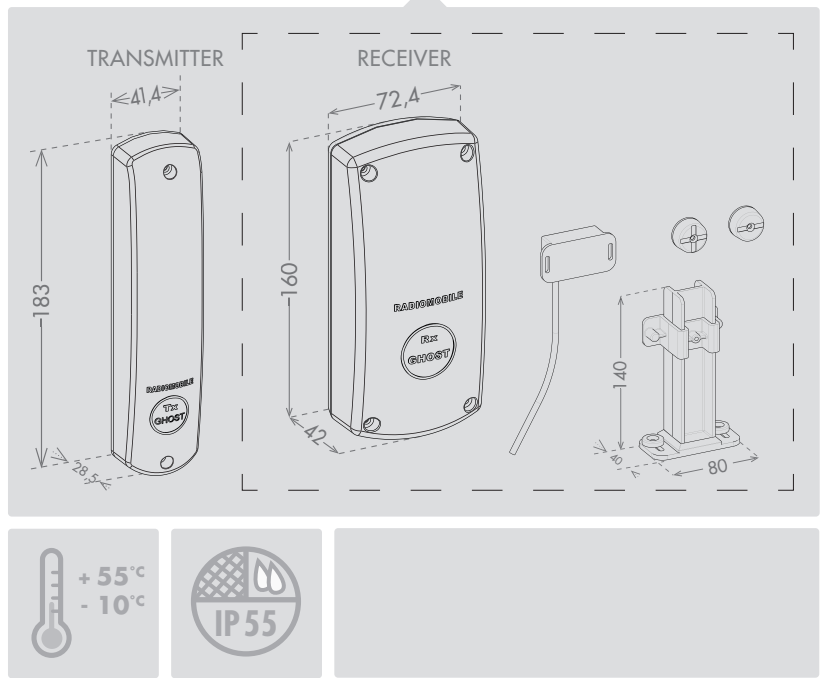

TEMPERATURE DEVICE IP RATING

RADIO EVO GHOST RX 868MHZ

code: **CESCHACC0003A**

RADIO EVO GHOST TX 868MHZ

code: **CESCHACC0010A**



- * Disponibile anche in versione integrata nei modelli **MAXXI CND, COMPATTA CND**
- * Built-in version available on **MAXXI CND, COMPATTA CND**



● ● ● ● ● CABLE CONNECTION



SCHEDA DI CONTROLLO

code: **CESCHACC0012A (SAFETY CATEGORY 2 PL D)**

code: **CESCHACC0014A (SAFETY CATEGORY 3 PL E)**

~
8,2 kΩ

IMQ



SCHEDA DI CONTROLLO

🇮🇹 Scheda di controllo per bordi sensibili resistivi (8,2KΩ). Dotata di due canali, garantisce l'autoverifica continua del sistema che viene bloccato in caso di anomalie. Disponibile in categoria di protezione 2 PL D (SCHED2) o categoria di protezione 3 PL E (SCHED3).

🇬🇧 Control board for resistive safety edges (8,2KΩ). With two channels, ensures the continuous system surveillance and block it in case of anomalies. Available in protection category 2 PL D (SCHED2) or protection category 3 PL E (SCHED3).

SCATOLA

code: **CESCHACC0013A**



🇫🇷 Carte de contrôle pour bords sensibles résistifs (8,2KΩ). Dotée de deux canaux, elle garantit la vérification automatique continue du système qui est bloqué en cas d'anomalie. Disponible en catégorie de protection 2 PL D (SCHED2) ou catégorie de protection 3 PL E (SCHED3).

🇩🇪 Steuerkarte für Widerstandskontaktleisten (8,2 kΩ), die zweikanalig ist und das System laufend selbstprüfend macht, wobei es im Fall einer Störung gesperrt wird. Sie ist in den Schutzarten 2 PL D (SCHED2) und 3 PL E (SCHED3) erhältlich.

🇪🇸 Tarjeta de control para bordes sensibles resistivos (8,2KΩ). Dotada de dos canales, garantiza la autoverificación continua del sistema, que se bloquea en caso de anomalía. Disponible en clase de protección 2 PL D (SCHED2) o 3 PL E (SCHED3).



ERCOLE CREMAGLIERA

code: **CEERCACC0001B (STAFFA VERSO IL BASSO)**

CEERCACC0002B (STAFFA VERSO L'ALTO)



IT ERCOLE è una cremagliera modulare in nylon, con anima di rinforzo in ferro. Molto versatile, ha la possibilità di essere installata con le staffe verso l'alto oppure verso il basso. Semplice e veloce da installare, grazie agli spessori modulari, è possibile montarla anche su cancelli non perfettamente rettilinei.

UK ERCOLE gear rack is made of a solid steel body with modular plastic covers locked together. The gear rack is secured with reversible brackets which can be put over or under rack's teeth. Quick and easy to install, has also modular spacers of 3mm allowing you to align the rack on very curved systems.

FR ERCOLE est une crémaillère modulaire en nylon avec un corps de renforcement en acier. Très polyvalente, elle offre la possibilité d'être installée avec les supports vers le haut ou vers le bas. Simple et facile à installer grâce aux surépaisseurs modulaires, il est également possible de la monter sur des portails qui ne seraient pas parfaitement rectilignes.

DE ERCOLE ist ein modulares Zahnstangensystem aus Nylon mit eingelegter Metallverstärkung. Es ist sehr vielseitig und ist mit nach oben oder nach unten gerichteten Stegen montierbar, weiterhin ist es schnell und einfach installierbar und dank der Zwischenstücke auch an nicht perfekt geraden Türkanten verwendbar.

ES ERCOLE es una cremallera modular de nailon dotada de núcleo de refuerzo de hierro. Dada su gran versatilidad, es posible instalarla con los soportes mirando hacia arriba o bien hacia abajo. Se instala de forma fácil y rápida gracias a los espesores modulares y es posible montarla incluso en portones que no son perfectamente rectilíneos.

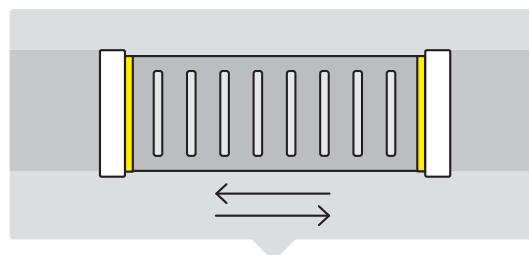

APPLICATIONS

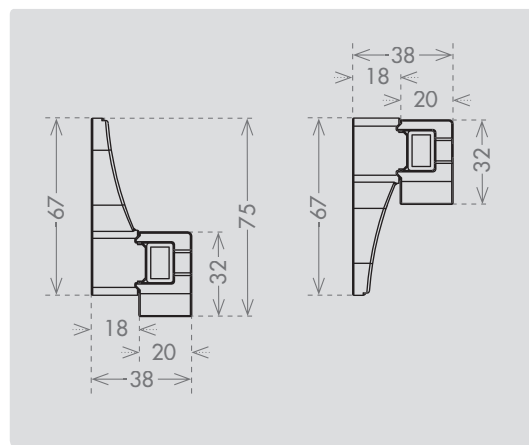

SIZES

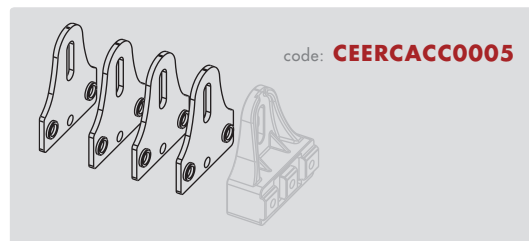

ACCESSORIES

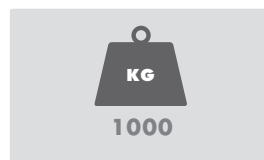

MAX LOAD

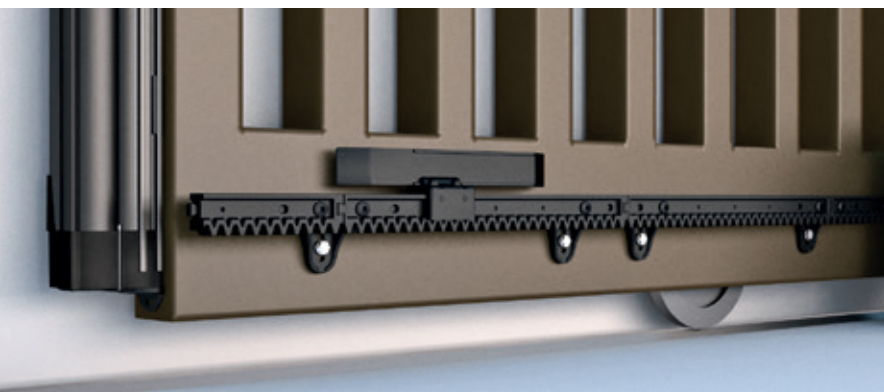



STAFFA PIÙ

code: **CEERCACC0008**

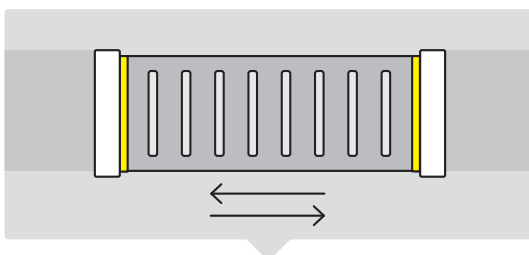



APPLICATIONS

 STAFFA PIÙ è un sistema di bloccaggio in nylon di alta qualità, per cremagliere in ferro. Ha la possibilità di essere installata verso l'alto oppure verso il basso.

 STAFFA PIÙ is a nylon blocking system that facilitates the installation of the iron rack on sliding gates. Can be fitted over or under rack's teeth.

 STAFFA PIÙ est un système de blocage en nylon de grande qualité pour crémaillère en fer. Il est réversible et permet d'être installé vers le haut ou vers le bas.

 STAFFA PIÙ ist ein qualitativ besonders hochwertiges Sperrsystem aus Nylon für Zahnstangen aus Metall. Es ist aufwärts oder abwärts gerichtet montierbar.

 STAFFA PIÙ es un sistema de bloqueo de nailon de alta calidad para cremalleras de hierro. Es posible instalarlo mirando hacia arriba o bien hacia abajo.

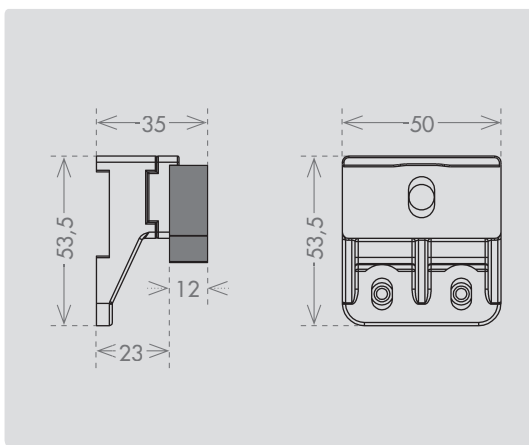

SIZES

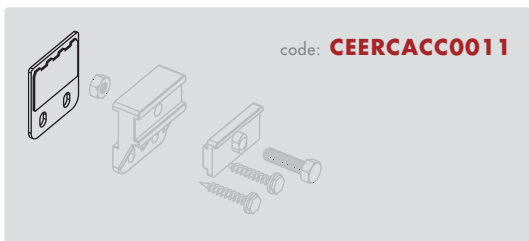

code: **CEERCACC0011**

ACCESSORY



MAX LOAD

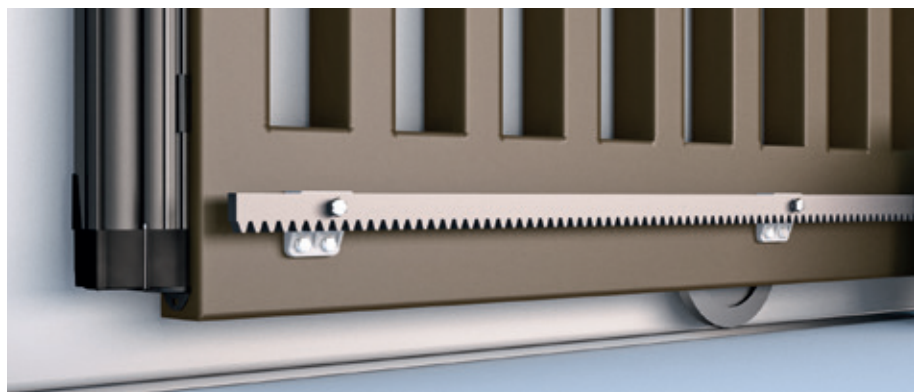
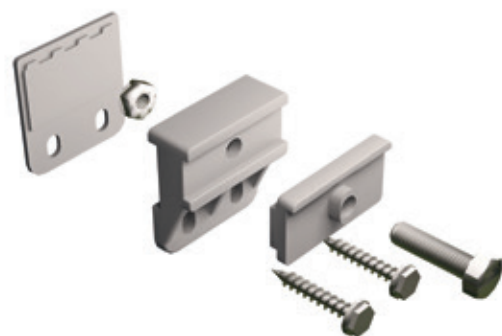



STAFFA EASY

code: **CEERCACC0007**



IT STAFFA EASY è un sistema di bloccaggio in nylon di alta qualità, per cremagliere in ferro. Ha la possibilità di essere installata in verticale oppure in orizzontale.

UK STAFFA EASY is a nylon blocking system that facilitate the installation of the iron rack on sliding gates. Can be fitted vertically or horizontally.

FR STAFFA EASY est un système de blocage en nylon de grande qualité pour crémaillère en fer. Il est possible de l'installer en position verticale ou horizontale.

DE STAFFA EASY ist ein qualitativ besonders hochwertiges Sperrsystem aus Nylon für Zahnstangen aus Metall. Horizontal oder vertikal montierbar.

ES STAFFA EASY es un sistema de bloqueo de nailon de alta calidad para cremalleras de hierro. Es posible instalarlo en posición vertical u horizontal.

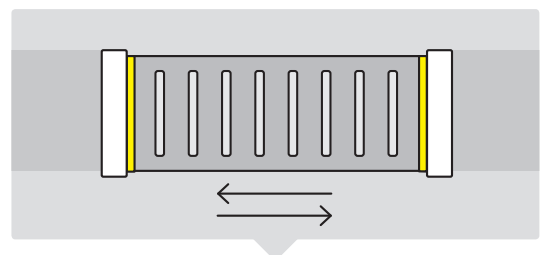

APPLICATIONS

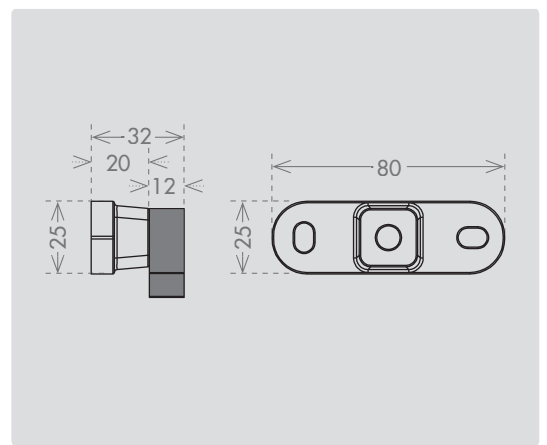

SIZES



MAX LOAD

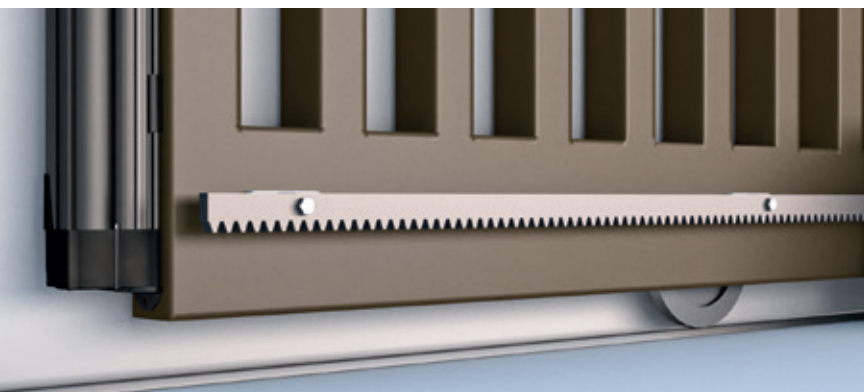





PROFILO 30°

the 30° profile for a 360° safety

code: **CEDSACC00001 / CEDSACC00002**

 Il profilo inclinato migliora la sensibilità del bordo sensibile contro il pericolo di convogliamento. Abbinato al bordo sensibile COMPATTA riduce il gap tra anta scorrevole e punto fisso di 24 mm. Con MINI/MINIROLL su cancelli a battente permette di ridurre lo spazio tra l'anta e il suolo di 13 mm.

 The inclined profile increases the performance of the safety edge against the danger of conveyance. Combined with COMPATTA safety edge it reduces the gap between the leaf and the fixed element by 24 mm. With MINI/MINIROLL on swing gates, it reduces the space between the leaf and the floor by 13 mm.

 Le profil incliné augmente les performances de la bordure de sécurité contre le danger de transport. Associé au bord de sécurité COMPATTA, il réduit l'écart entre le vantail et l'élément fixe de 24 mm. Avec MINI/MINIROLL sur portails battants, il réduit l'espace entre le vantail et le sol de 13 mm.



 Das geneigte Profil erhöht die Leistung der Sicherheitskante gegen die Gefahr des Mitreißens. In Kombination mit der COMPATTA-Sicherheitskante verringert es den Abstand zwischen Flügel und festem Element um 24 mm. Mit MINI/MINIROLL an Drehtoren verringert es den Abstand zwischen Flügel und Boden um 13 mm.

 El perfil inclinado aumenta las prestaciones de la banda de seguridad contra el peligro de transporte. Combinado con la banda de seguridad COMPATTA reduce de 24 mm el espacio entre la hoja y el elemento fijo. Con MINI/MINIROLL en puertas batientes reduce de 13 mm el espacio entre la hoja y el suelo.

APPLICAZIONE SU CANCELLI SCORREVOLI
APPLICATION ON SLIDING GATES

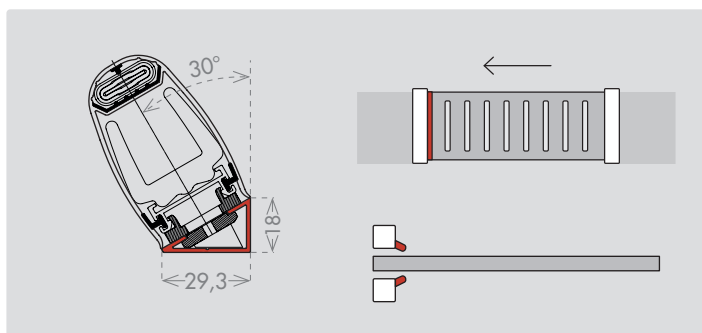

COMPATIBILE CON
COMPATIBLE WITH

COMPATTA CND
COMPATTA PROTO

MISURE DISPONIBILI
AVAILABLE SIZES

2000
 3000

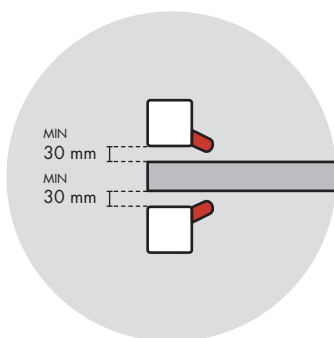

APPLICAZIONE SU CANCELLI A BATTENTE
APPLICATION ON SWING GATES

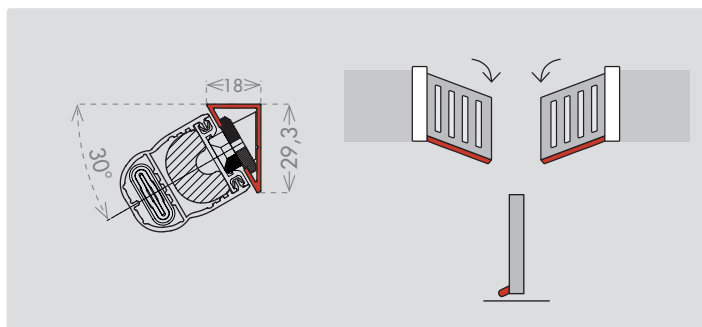

COMPATIBILE CON
COMPATIBLE WITH

MINI CND
MINIROLL CND

MISURE DISPONIBILI
AVAILABLE SIZES

2000
 3000

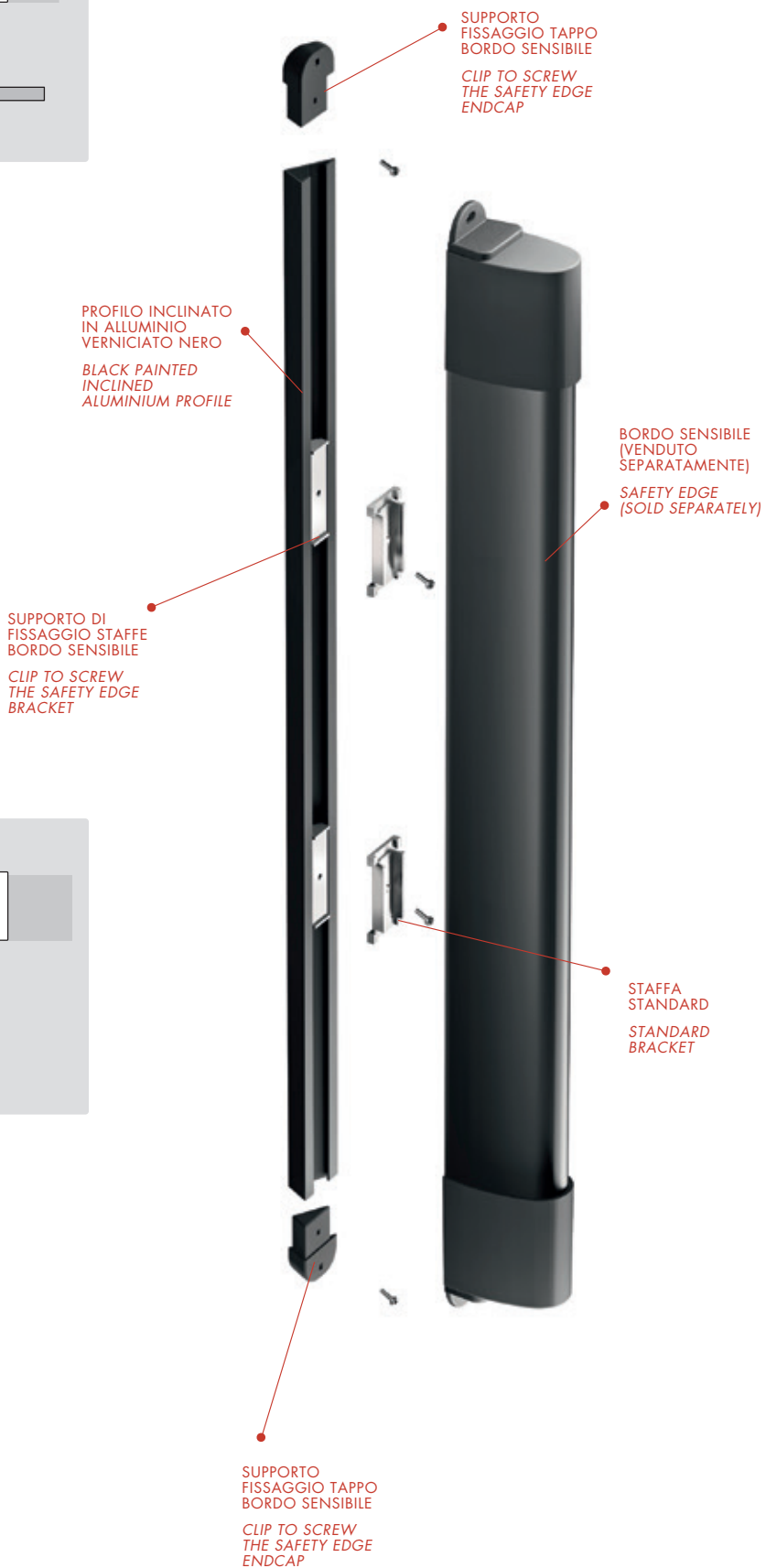
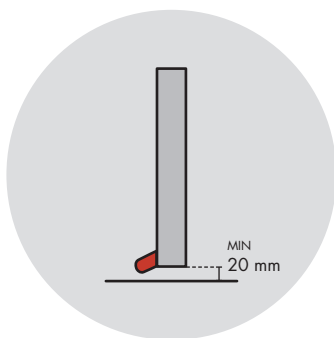



Le immagini presenti in questo catalogo sono indicative e possono variare dagli articoli originali.
La C.C.E. srl si riserva il diritto di effettuare migliorie tecniche senza preavviso.

*The images on this catalogue are for displaying purposes only and can vary from the real item.
C.C.E. srl reserves the right to make technical upgrades without prior notice.*

Les images contenues dans ce catalogue sont indicatives et peuvent ne pas correspondre exactement aux articles d'origine.
L'entreprise C.C.E. srl se réserve le droit d'apporter toute modification technique sans préavis.

*Die in diesem Prospekt gezeigten Darstellungen sind unverbindlich, sie können vom Aussehen der Produkte abweichen.
C.C.E. behält sich das Recht zu technischen Verbesserungen ohne Vorankündigung vor.*

Las imágenes presentes en este catálogo son indicativas y pueden variar respecto a los artículos originales.
C.C.E. srl se reserva el derecho de efectuar modificaciones técnicas sin aviso previo.

C.C.E. srl
Costruzioni Chiusure Ermetiche

Via dell'Artigianato, 16
35010 Villa del Conte (PD) - ITALY
Tel. +39 049 9325073
Fax +39 049 9325384
www.cce.it
e-mail: safety@cce.it

