

13x28 FILLER

cod. AS1328FIL

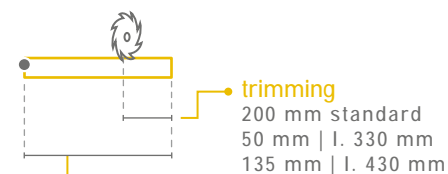

lengths

330 430 530 630 730 830 930 1030 1130
1230 1330 1430 1530 1630 1730 1830 mm

plunger type

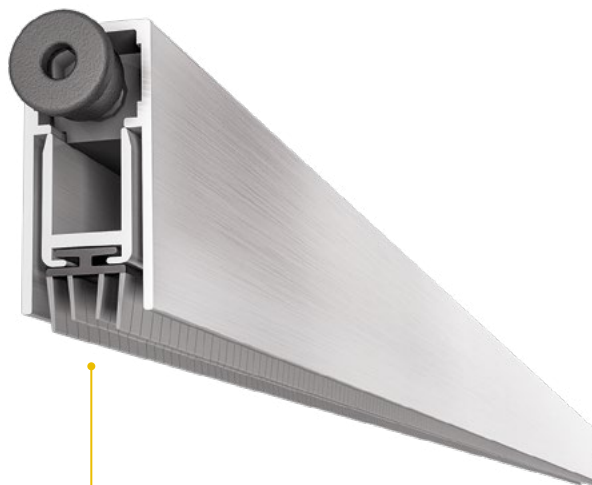
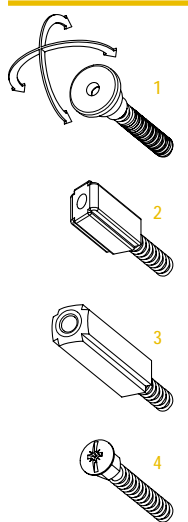

application

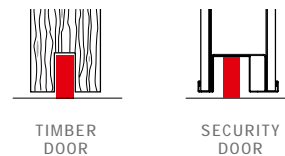

size 13x28 mm

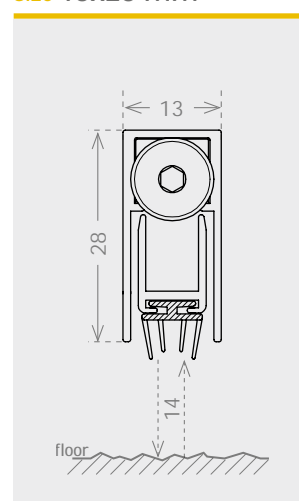

seals

FL2



THERM

27 dB Rw

fixing type

2F

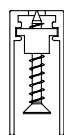

3F

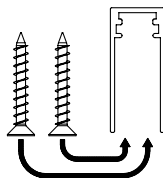

closing plug included



optional

Z

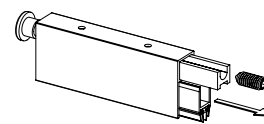

ACTUATOR PIVOT cod. ACAPIV p. 153

IT La guarnizione Filler si adatta a tutte le imperfezioni del pavimento, fughe di piastrelle, dislivelli, per una chiusura perfetta. Questo modello, leggero ed economico, è dotato di guarnizione Filler per pavimenti irregolari.

DE Die Türdichtung Filler passt sich allen Bodenunregelmäßigkeiten, Fliesenfugen und Höhenunterschieden an und schließt so perfekt. Dieses leichte und wirtschaftliche Modell verfügt über eine Dichtlippe Filler für unregelmäßige Böden.

FR Le joint Filler s'adapte à toutes les imperfections du sol, joints de carrelage, irrégularités, pour une fermeture parfaite. Ce modèle, léger et économique, est doté du joint Filler pour sols irréguliers.

ES La junta Filler se adapta a todas las imperfecciones del suelo, fugas de baldosas y desniveles, para un cierre perfecto. Este modelo, ligero y económico, dispone de una junta Filler para suelos irregulares.

RU Filler

Filler

