

# 13X28 SQUADRETTE

cod. AS1328SQ

**EN** One of the all-time CCE classics, available with many different combination of seals and plungers, with steel brackets fixing system. It can be equipped with the "No Tools" plunger and it can be installed on pivoting door in combination with Actuator Pivot accessory.

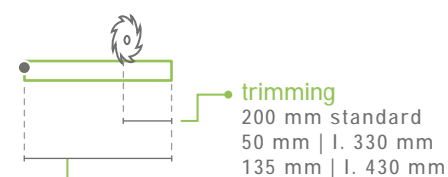

### trimming

200 mm standard  
50 mm | l. 330 mm  
135 mm | l. 430 mm

### lengths

330 430 530 630 730 830 930 1030 1130  
1230 1330 1430 1530 1630 1730 1830 mm

### plunger type

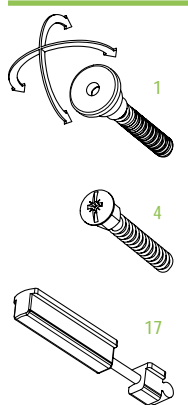

### certification



### application

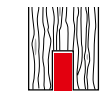

TIMBER DOOR





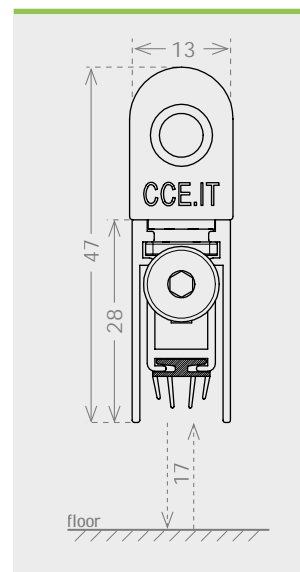

SECURITY DOOR

### size 13x28 mm



### seals

<p><b>A</b></p>  <p>THERM</p> <p><b>27 dB Rw</b> IFT Cert. n. PB-G03-04 en-01_PB17</p>	<p><b>B</b></p>  <p>SIL</p> <p><b>34 dB Rw</b> IFT Cert. n. PB-G03-04 en-01_PB14</p>
<p><b>C</b></p>  <p>THERM</p> <p><b>28 dB Rw</b> IFT Cert. n. PB-G03-04 en-01_PB16</p>	<p><b>D</b></p>  <p>PP</p>

### fixing type

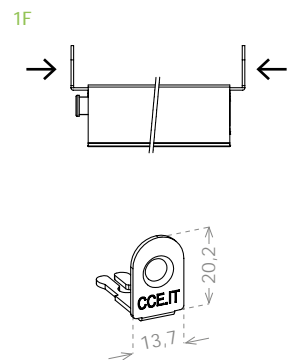

### closing plug included



### optional

**Z2**

**DOUBLE PLUNGER KIT**  
cod. ACKITDP p. 152

---

**ACTUATOR PIVOT**  
cod. ACAPIV p. 153

**IT** Uno dei modelli storici di CCE, disponibile in molte combinazioni diverse di pulsanti e guarnizioni, offerto con il fissaggio tramite squadrette laterali. Può essere utilizzato con il pulsante di spinta "No Tools" o anche su porte pivotanti con l'utilizzo dell'accessorio Actuator Pivot.

**DE** Eines der historischen Modelle von CCE, mit vielen verschiedenen Druckknopfkombinationen und Dichtlippen erhältlich. Befestigung mit seitlichen Laschen. Es kann auch mit dem Druckknopf „No Tools“ oder mit dem Zubehörteil Actuator Pivot an Pivottüren angewendet werden.

**FR** Un des modèles historiques de CCE, disponible dans de nombreuses combinaisons de boutons poussoir et de joints, ici dans sa configuration de fixation avec équerres latérales. Il peut être utilisé avec le bouton poussoir "No tools" et également être installé sur les portes pivot avec l'accessoire Actuator Pivot.

**ES** Uno de los modelos históricos de CCE, disponible en muchas combinaciones de pulsadores y juntas, ofrecido con la fijación mediante escuadras laterales. Puede utilizarse con el pulsador de empuje "No Tools" o también en puertas pivotantes utilizando el accesorio Actuator Pivot.

**RU**

CCE,

«No Tools»,

Actuator Pivot.







